



# IMPROVING THERMAL AND ELECTRIC ENERGY EFFICIENCY AT CEMENT PLANTS: INTERNATIONAL BEST PRACTICE



*Creating Markets, Creating Opportunities*

© 2017 International Finance Corporation

All rights reserved.

2121 Pennsylvania Avenue, N.W.

Washington, D.C. 20433

[ifc.org](http://ifc.org)

*The material in this work is copyrighted. Copying and/or transmitting portions or all of this work without permission may be a violation of applicable law. IFC does not guarantee the accuracy, reliability or completeness of the content included in this work, or for the conclusions or judgments described herein, and accepts no responsibility or liability for any omissions or errors (including, without limitation, typographical errors and technical errors) in the content whatsoever or for reliance thereon.*

Cover Image: Bigstock

# TABLE OF CONTENTS

ABBREVIATIONS .....	iv
ACKNOWLEDGMENTS .....	v
ABSTRACT .....	v
FOREWORD .....	vi
<b>1 THE CEMENT MANUFACTURING PROCESS .....</b>	<b>1</b>
<b>1.1 Raw Material Preparation .....</b>	<b>1</b>
<b>1.2 Fuel Preparation .....</b>	<b>1</b>
<b>1.3 Clinker Production .....</b>	<b>3</b>
<b>1.4 Clinker Cooling .....</b>	<b>3</b>
<b>1.5 Finish Grinding .....</b>	<b>4</b>
<b>2 ENERGY EFFICIENCY TECHNOLOGIES AND MEASURES .....</b>	<b>5</b>
<b>2.1 Raw Material Preparation .....</b>	<b>6</b>
2.1.1 High-Efficiency Fans and Variable Speed Drives for Mill Vents .....	6
2.1.2 Pre-grinding for Ball Mills .....	7
<b>2.2 Fuel Preparation .....</b>	<b>8</b>
2.2.1 High-Efficiency Fans and Variable Speed Drives for Mill Vents .....	8
<b>2.3 Clinker Production .....</b>	<b>8</b>
2.3.1 Process Controls and Optimization .....	8
2.3.2 Modern Multi-Channel Burners .....	10
2.3.3 Low-Pressure Drop Cyclones for Suspension Preheaters .....	11
2.3.4 Waste Heat Recovery for Power Production .....	12
2.3.5 Oxygen Enrichment Technology .....	18
<b>2.4 Clinker Cooling .....</b>	<b>21</b>
2.4.1 Optimizing Heat Recovery .....	21
2.4.2 Variable Speed Drives for Cooler Fans .....	23
<b>2.5 Finish Grinding .....</b>	<b>24</b>
2.5.1 Process Control and Management in Finish Grinding .....	24
2.5.2 Replacing a Ball Mill with a Vertical Roller Mill, High-Pressure Grinding Rolls, or Horomill® for Finish Grinding .....	26
2.5.3 Optimizing the Operation of a Cement Mill .....	30
2.5.4 High-Pressure Roller Press as a Pre-grinding Step for Ball Mills .....	31
2.5.5 Improved Grinding Media for Ball Mills .....	32
2.5.6 High-Efficiency Classifiers .....	33
2.5.7 High-Efficiency Fans for Cement Mill Vents .....	34

<b>2.6 General Measures</b>	<b>35</b>
2.6.1 High-Efficiency Motors and Efficient Drives	35
2.6.2 Variable Speed Drives	36
2.6.3 Preventative Maintenance	37
2.6.4 Compressed Air System Optimization and Maintenance	37
2.6.4.1 Compressed Air System Maintenance	39
2.6.4.2 Reducing Leaks in Compressed Air Systems	39
2.6.4.3 Compressor Controls	40
<b>3 ENERGY EFFICIENCY PROJECT IMPLEMENTATION BARRIERS</b>	<b>41</b>
<b>4 BUSINESS MODELS</b>	<b>43</b>
<b>4.1 Direct Implementation</b>	<b>43</b>
4.1.1 Direct Loans (Senior Debt)	43
4.1.2 Subordinated Debt Financing (Mezzanine Financing)	44
4.1.3 Equity Financing	44
4.1.4 Leasing	44
4.1.5 Partial Loan Guarantees	45
<b>4.2 Energy Performance Contracting Model</b>	<b>45</b>
4.2.1 Definitions and Basic Concepts	45
4.2.2 Shared Savings Energy Performance Contract	45
4.2.3 Guaranteed Savings Energy Performance Contract	46
4.2.4 Chauffage	46
4.2.5 Comparative Analysis of the Different Models	47
<b>4.3 Public-Private Partnership</b>	<b>47</b>
<b>4.4 Special Purpose Vehicle</b>	<b>48</b>
<b>5 INTERNATIONAL BEST PRACTICE BUSINESS MODELS FOR IMPLEMENTING ENERGY EFFICIENCY PROJECTS IN INDUSTRY</b>	<b>49</b>
<b>5.1 Lending Programs</b>	<b>49</b>
5.1.1 Promoting an Energy Efficiency Market in Chile	49
5.1.2 China Utility-Based Energy Efficiency Program (CHUEE)	50
5.1.3 Bangkok Mitsubishi UFJ Lease Ltd (BMUL) Risk-Sharing Project	52
<b>5.2 Equity Financing (Private Equity, Risk/Venture Capital, etc.)</b>	<b>53</b>
5.2.1 Clean Resources Asia Growth Fund	53
<b>5.3 Partial Guarantee Mechanism</b>	<b>53</b>
5.3.1 The Energy Efficiency Guarantee Mechanism	53
5.3.2 Krakow Energy Efficiency Project	54
<b>5.4 ESCO Business Models</b>	<b>54</b>
5.4.1 Green for Growth Fund	54
<b>6 BRAZILIAN MECHANISMS TO SUPPORT THE USE OF DIFFERENT BUSINESS MODELS</b>	<b>56</b>
<b>6.1 Taking on Debt</b>	<b>56</b>
<b>6.2 Energy Performance Contracting</b>	<b>57</b>

# LIST OF FIGURES

<b>Figure 1:</b> Cement Production Process Flow Schematic and Typical Energy Efficiency Measures	2
<b>Figure 2:</b> Rotary Cement Kiln (Dry Process with Cyclonic Preheaters)	4
<b>Figure 3:</b> Schematic Depiction of Control Points and Parameters in a Kiln System Control and Management System	9
<b>Figure 4:</b> Typical Waste Heat Recovery System Using Steam Rankine Cycle	13
<b>Figure 5:</b> Waste Heat Recovery Installations in the Cement Industry	15
<b>Figure 6:</b> Installed Costs for Waste Heat Recovery Systems	16
<b>Figure 7:</b> Installed Costs for Chinese Stem-based Waste Heat Recovery Systems	16
<b>Figure 8:</b> Fixed Static Inlet Section for a Clinker Cooler	22
<b>Figure 9:</b> Optimized Cooling Air Distribution for a Typical Eight-compartment Reciprocating Grate Cooler	22
<b>Figure 10:</b> Power Consumption of Fan Installations with Different Control Methods	24
<b>Figure 11:</b> Measurement and Manipulation Points in a Process Control System	25
<b>Figure 12:</b> High-Pressure Roller Press for Finish Grinding	27
<b>Figure 13:</b> Horomill® Concept	28
<b>Figure 14:</b> Basic Layout of Cement Grinding Using Horomill®	28
<b>Figure 15:</b> Energy Savings Potential of Vertical Roller Mills versus Ball Mills	29
<b>Figure 16:</b> Energy Savings Potential of Horomill®	29
<b>Figure 17:</b> High-Pressure Roller Press as a Pre-grinding Step for Ball Mills	31
<b>Figure 18:</b> High-Pressure Roller Press as a Semi-finish Pre-grinder with Two-stage Separator	32
<b>Figure 19:</b> Schematic of a High-Efficiency Separator/Classifier	33
<b>Figure 20:</b> Efficiency Ranges for Different Motor Classification	35
<b>Figure 21:</b> Structure of Various Financing Methods	43
<b>Figure 22:</b> Partial Loan Guarantee	45
<b>Figure 23:</b> Shared Savings Financial Model	45
<b>Figure 24:</b> Guaranteed Savings Financial Model	46
<b>Figure 25:</b> “Chauffage” Financial Model	46
<b>Figure 26:</b> Special Purpose Vehicle Financial Model	48
<b>Figure 27:</b> Institutional Arrangements of CHUEE Program	51
<b>Figure 28:</b> Krakow Energy Efficiency Project	54
<b>Figure 29:</b> Green for Growth Fund Institutional Structure	55

## LIST OF TABLES

Table 1: Specific Thermal Energy Consumption by Rotary Kiln Type . . . . .	4
Table 2: Production Gains Achieved in Different Plants Using Oxygen Enrichment Technology . . . . .	18
Table 3: Improvements in Alternative Fuel Use with the Use of Oxygen Enrichment . . . . .	19
Table 4: Impact of Oxygen Injection on Alternative Fuels and Production . . . . .	20
Table 5: Monitor and Control Parameters . . . . .	25
Table 6: Use of Expert Control System . . . . .	26
Table 7: Energy Performance Contracting Models . . . . .	47

## ABBREVIATIONS

AC	Alternating Current	IFC	International Finance Corporation
BNDES	Banco Nacional de Desenvolvimento Econômico e Social (National Bank for Social and Economic Development)	IFRS	International Financial Reporting Standards
DC	Direct Current	kWh	Kilowatt hour
ESCO	Energy Services Company	MJ	Megajoule
FASB	Financial Accounting Standards Board	MW	Megawatt
GJ	Gigajoule	ORC	Organic Rankine Cycle
IASB	International Accounting Standards Board	PID	Proportional–integral–derivative
		PP&E	Property, Plant, and Equipment
		U.S. GAAP	U.S. Generally Accepted Accounting Principles

## ACKNOWLEDGMENTS

This report was produced in cooperation between IFC, SNIC (Sindicato Nacional da Indústria do Cimento), ABCP (Associação Brasileira de Cimento Portland), and INT (Brazil's National Institute of Technology).

Development of the report was managed by Alexander Sharabaroff (IFC), Gonzalo Visedo (SNIC), and Marcelo Pecchio (ABCP). The primary authors include Stephanie Nour and Pierre Langlois of Econoler, Bruce Hedman, and Victor Turnell.

Professor Dr. José Goldemberg, Dr. Mauricio Francisco Henriques Junior and Fabrício dos Santos Dantas of INT shared invaluable insights to the report.

The team would like to acknowledge a tremendous contribution to this report by Michel Folliet (IFC), Jigar Shah (IFC), José Otavio Carvalho (President, SNIC), Renato José Giusti (President, ABCP), Hugo da C. Rodrigues Filho (ABCP), and Antonia Jadranka Suto (ABCP); Araceli Fernandez Pales, Kira West, and Steffen Dockweiler of the International Energy Agency (IEA); and Alexios Pantelias, John Kellenberg, Jeremy Levin, Luis Alberto Salomon, Sivaram Krishnamoorthy, Yana Gorbatenko and Alexander Larionov of IFC.

## ABSTRACT

This report and an accompanying report on alternative fuels provide a summary of international best practice experience in the cement sector and focus on specific technical measures that could be implemented by cement plants to reduce their operating costs and improve their carbon footprints. The reports provide a plethora of practical information from implemented projects and include detailed technical descriptions, capital and operating costs, and case studies and references from locations where the measures have been implemented. A combination of general and in-depth information will make these reports a helpful read to both management and technical and operating personnel of cement plants as well as to a larger range of stakeholders.

## FOREWORD

Cement is paramount for economic development and poverty reduction in emerging markets. Along with aggregates and water, cement is the key ingredient in the production of concrete, and, as such, is an essential construction material that enables large infrastructure projects in energy, water, and transport, as well as, importantly, the construction of modern buildings and urban infrastructure. Given the rapid urbanization rates in developing countries, cement is crucial for delivering on the climate-smart cities agenda. Emerging markets have been rapidly increasing their cement use and now account for over 90 percent of cement consumption worldwide (4.1 billion tons in 2016).

Cement accounts for at least 5 percent of anthropogenic emissions of greenhouse gases, and, according to some estimates, this share may be even higher. At the same time, energy-related expenses in the cement sector, mostly on fossil fuels and electricity, account for 30 to 40 percent of the industry's cash costs. While current energy prices are still recovering from the global financial and economic crises, there is no doubt that they will continue to increase in the long run. In recent years, the cement industry has been successful in reducing its operating costs and improving its carbon footprint (emissions per unit of output) by improving energy efficiency, increasing the use of alternative fuels, and deploying renewable energy sources.

With a cumulative investment portfolio in cement of over \$4.2 billion, IFC has accumulated a vast experience in the industry, including in sustainable energy projects. To share its knowledge with external stakeholders and to promote sustainable practices in the sector, IFC commissioned two studies on international best practice in the cement sector, covering thermal and electric energy efficiency, and alternative fuels. These studies were developed as part of the Brazil Low Carbon Technology Roadmap led by the National Cement Industry Association of Brazil (SNIC), the Brazilian Association of Portland Cement (ABCP), the International Energy Agency (IEA), the Cement Sustainability Initiative (CSI) of the World Business Council for Sustainable Development (WBCSD), and IFC.

This report, and an accompanying report on alternative fuels, provide a summary of international best practice experience in the cement sector and focus on specific technical measures that could be implemented by cement plants to reduce their operating costs and improve their carbon footprints. The reports provide a plethora of practical information from implemented projects and include detailed technical descriptions, capital and operating costs, and case studies and references from locations where the measures have been implemented. A combination of general and in-depth information will make these reports a helpful read to both management and technical and operating personnel of cement plants as well as to a larger range of stakeholders.



**Michel Folliet**

Chief Industry Specialist

*Cement, Manufacturing, Agriculture and Services*



**Milagros Rivas Saiz**

Manager

*Cross Industry Advisory*



**Jigar Shah**

Principal Industry Specialist

*Energy Efficiency, Climate Business Department*



Cement production is a resource-intensive practice involving large amounts of raw materials, energy, labor, and capital. Cement is produced from raw materials such as limestone, chalk, shale, clay, and sand. These raw materials are quarried, crushed, finely ground, and blended to the correct chemical composition. Small quantities of iron ore, alumina, and other minerals may be added to adjust the raw material composition. Typically, the fine raw material is fed into a large rotary kiln<sup>1</sup> (cylindrical furnace) where it is heated to about 1,450 degrees Celsius (2,640 degrees Fahrenheit). The high temperature causes the raw materials to react and form a hard nodular material called “clinker.” Clinker is cooled and ground with gypsum and other minor additives to produce cement.

Beyond the mining of the raw materials, there are five major process steps in cement production (see Figure 1). Each of these steps has specific energy requirements and consumption patterns, as well as various energy efficiency measures that can be applied to reduce energy use and increase productivity depending on the characteristics of and conditions at each individual cement plant. The remaining energy consumption at cement plants is used for final-product packaging, lighting, and building services. These are typically minor electricity uses compared to the major electricity and fuel consumption in the five major process steps.

## 1.1 RAW MATERIAL PREPARATION

Raw material preparation provides a mixture of raw materials and additives that has the right chemical composition and particle size distribution necessary for clinker production. For plants that receive their raw materials already crushed, this stage usually involves grinding (milling), classification, mixing, and storage. Raw material preparation is an electricity-intensive production step requiring about 25 to 35 kilowatt hours (kWh) per ton of raw material, although it could require as little as 11 kWh per ton.<sup>2</sup>

After primary and secondary size reduction, the raw materials are further reduced in size by grinding. The grinding differs with the pyroprocessing process (kiln type) used. In dry processing, the materials are ground into a flowable powder in horizontal ball mills or in vertical roller mills. In a ball mill, steel-alloy balls are responsible for decreasing the size of the raw material pieces in a rotating cylinder. Rollers on a round table provide size reduction in a roller mill. Waste heat from the kiln exhaust or the clinker cooler vent, or auxiliary heat from a standalone air heater before pyroprocessing, is often used to further dry the raw materials. The moisture content in the raw material feed of a dry kiln is typically around 0.5 percent (0 percent to 0.7 percent).

## 1.2 FUEL PREPARATION

Solid fuel preparation involves optimizing the size and moisture content of the fuel fed to the pyroprocessing system of the kiln. Solid fuels are typically coal, petrocake, and/or a mix of alternative fuels. Vertical roller mills are the dominant choice for solid fuel grinding, with a worldwide share of fuel processing capacity of around 90 percent. Ball mills, often used for fuels with poor grindability, make up the remaining

---

1 Clinker can be produced in many different pyroprocessing systems or kiln types. There are two basic kiln configurations—vertical (or shaft) kilns and rotary kilns—and many variations of each type are in use around the world. Generally, shaft kilns are an older, smaller, less-efficient technology and have been phased out in most countries. Modern cement plants use variations on the dry rotary kiln technology, incorporating various stages of preheating and precalcining.

---

2 U.S. Environmental Protection Agency (EPA), *Available and Emerging Technologies for Reducing Greenhouse Gas Emissions from the Portland Cement Industry* (Washington, DC: October 2010).

**Figure 1: Cement Production Process Flow Schematic and Typical Energy Efficiency Measures**

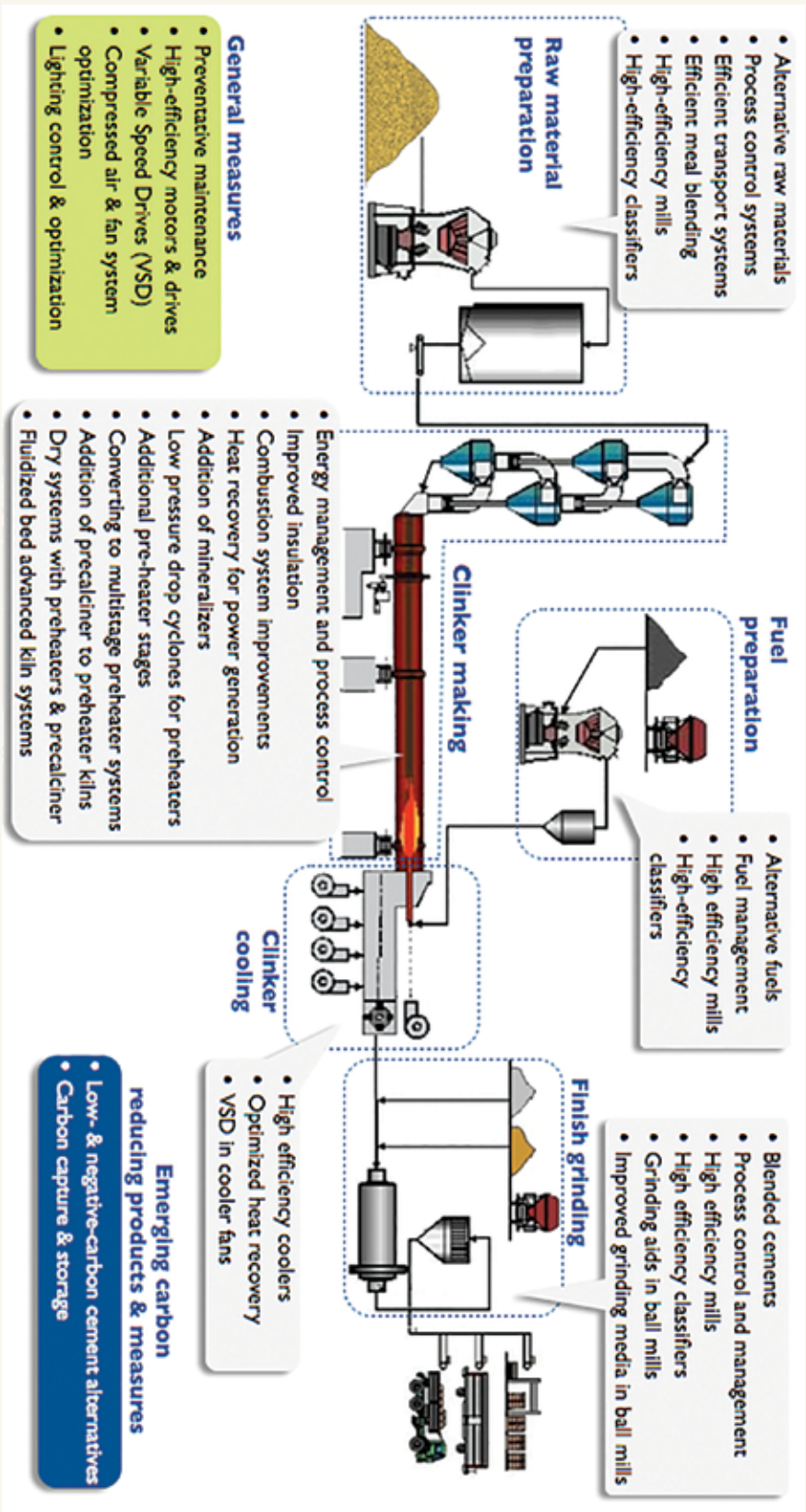

Source: Institute for Industrial Productivity, Industrial Energy Technology Database, <http://feed.innetwork.org/content/cement>.

10 percent.<sup>3</sup> Increasingly, alternative waste and byproduct streams—such as waste industrial oils and solvents, waste plastics, fractions of household waste, used tires, wastewater treatment sludge, and others—are being used as fuel. Some of these may require additional preparation infrastructure.

### 1.3 CLINKER PRODUCTION

Clinker production, or pyroprocessing, transforms raw materials (primarily limestone) into clinker (lime), the basic component of cement, and releases carbon dioxide during the transformation. Clinker production is the most energy-intensive stage in cement production, accounting for more than 90 percent of the total energy use and virtually all of the fuel use in the industry. Clinker is produced by pyroprocessing the raw materials in large kilns. Three important processes occur with the raw material mixture during pyroprocessing. First, all moisture is driven off from the materials. Second, the calcium carbonate in limestone dissociates into carbon dioxide and calcium oxide (free lime); this process is called calcination. Third, the lime and other minerals in the raw materials react to form calcium silicates and calcium aluminates, which are the main components of clinker. This third step is known as clinkering or sintering.

The main kiln type in use throughout the world is the rotary kiln (see Figure 2). In rotary kilns, a tube with a diameter of up to eight meters is installed at a three- to four-degree angle that rotates one to five times per minute. The kiln is normally fired at the lower end, and the ground raw material is fed into the top of the kiln, from where it moves down the tube countercurrent to the flow of gases and toward the flame end of the kiln. As the raw material passes through the kiln, it is dried and calcined, then finally enters into the sintering zone. In the sintering (or clinkering) zone, the combustion gas reaches a temperature of 1,800 to 2,000 degrees Celsius. Hot clinker is discharged from the lower end of the kiln and is immediately cooled in large air coolers to ensure clinker quality and to lower it to handling temperatures for downstream equipment. Cooled clinker is combined with gypsum and other additives and ground into a fine gray powder called cement. Many cement plants include the final cement grinding and mixing operation at the site. Others ship some or all of their clinker production to standalone cement-grinding plants situated close to markets.

---

<sup>3</sup> Ibid.

Rotary kilns are divided into two groups, dry process and wet process, depending on how the raw materials are prepared. In wet process systems, raw materials are fed into the kiln as slurry with a moisture content of 30 to 40 percent. Wet process kilns have much higher fuel requirements due to the amount of water that must be evaporated before calcination can take place. To evaporate the water contained in the slurry, a wet process kiln requires additional length and nearly 100 percent more kiln thermal energy compared to the most-efficient dry kiln (see Table 1). Wet process kilns tend to be older operations.

Three major variations of dry process systems are used worldwide: long dry kilns without preheaters, suspension preheater kilns, and preheater/precalciner kilns. In suspension preheater and preheater/precalciner kilns, the early stages of pyroprocessing occur in the preheater sections, a series of vertical cyclones (see Figure 2), before materials enter the rotary kiln. As the raw material is passed down through these cyclones, it comes into contact with hot exhaust gases moving in the opposite direction, and, as a result, heat is transferred from the gas to the material. Modern preheater/precalciner kilns also are equipped with a precalciner, or a second combustion chamber, positioned between the kiln and preheaters that partially calcines the material before it enters the kiln so that the necessary chemical reactions occur more quickly and efficiently. Depending on the drying requirements of the raw material, a kiln may have three to six stages of cyclones with increasing heat recovery with each extra stage. As a result, suspension preheater and preheater/precalciner kilns tend to have higher production capacities and greater fuel efficiency compared to other types of systems, as shown in Table 1.

### 1.4 CLINKER COOLING

Once the clinker is discharged to the clinker cooler from the kiln, it is cooled rapidly to minimize glass phase formation and to ensure maximum yield of alite (tricalcium silicate) formation, an important component for cement-hardening properties. The primary cooling technologies in use today are various configurations of grate coolers and older planetary coolers. In the grate cooler, the clinker is transported over a reciprocating grate through which air flows perpendicular to the clinker flow. In the planetary cooler (a series of tubes surrounding the discharge end of the rotary kiln), the clinker is cooled in a countercurrent air stream. Planetary clinkers are slowly being

**Figure 2:** Rotary Cement Kiln (Dry Process with Cyclonic Preheaters)

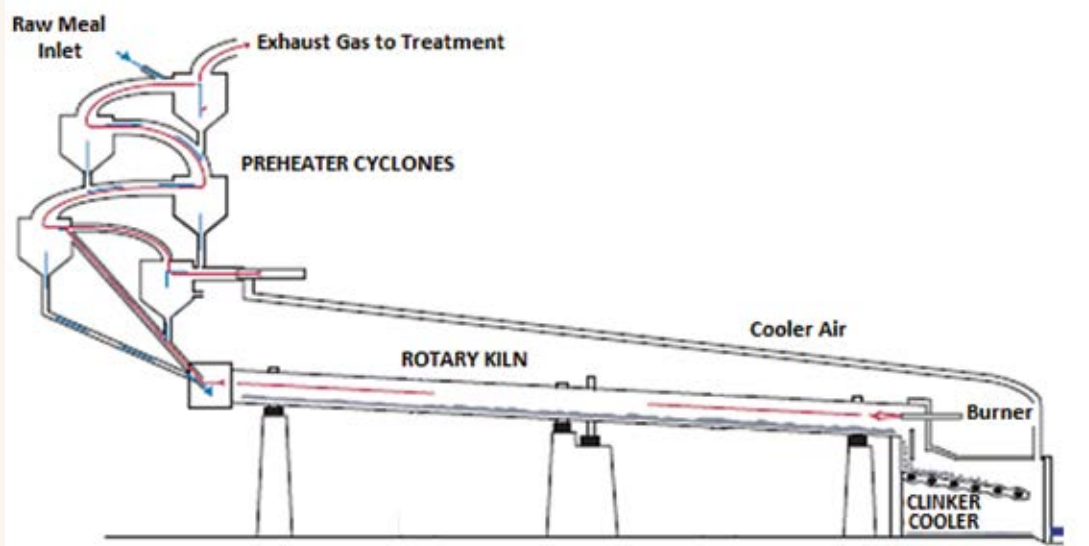

Source: U.S. Department of Energy, *Energy and Emissions Reduction Opportunities for the Cement Industry* (Washington, DC: 2003).

phased out as new generations of grate coolers enter the market with further operational and efficiency improvements. Modern clinker coolers route the heated air to the precalciner to serve as preheated combustion air, or to the preheaters to preheat raw material prior to entering the kiln. The primary energy

consumption in a clinker cooler is the electricity required to push cooling air through the cooler.

## 1.5 FINISH GRINDING

Once the clinker has been cooled, it must be crushed and mixed with other materials to produce the final cement product. After cooling, clinker is often stored in domes, silos, or bins. The material-handling equipment used to transport clinker from the clinker coolers to storage and then to the finish mill is similar to equipment used to transport raw materials (for example, belt conveyors, deep bucket conveyors, and bucket elevators). To produce cement, clinker nodules are ground to the consistency of powder. If the blending material is not already in a powdered state, it also must be crushed and ground prior to blending. Ordinary Portland cement is composed of 95 percent clinker and 5 percent additives. “Blended cement” is the term applied to cement that is made from clinker that has been ground with a larger share of one or more additives. These additives can include such materials as fly ash from power plants, blast furnace slag volcanic ash, and pozzolans. The finish grinding is typically done in ball mills, ball mills combined with roller presses, vertical roller mills, or roller presses. Coarse material is separated in a classifier and returned to the mill for additional grinding to ensure that the final product has uniform surface area.

**Table 1:** Specific Thermal Energy Consumption by Rotary Kiln Type

Kiln Type	Heat Input (MJ/ton of clinker)
Wet	5,860–6,280
Long Dry	4,600
1-Stage Cyclone Suspension Preheater	4,180
2-Stage Cyclone Suspension Preheater	3,770
4-Stage Cyclone Suspension Preheater	3,550
4-Stage Cyclone Suspension Preheater plus Calciner	3,140
5-Stage Cyclone Suspension Preheater plus Calciner plus High-Efficiency Cooler	3,010
6-Stage Cyclone Suspension Preheater plus Calciner plus High-Efficiency Cooler	<2,930

Source: Based on N. A. Madloul et al., “A Critical Review on Energy Use and Savings in the Cement Industries,” *Renewable and Sustainable Energy Reviews* 15, no. 4 (2011): 2,042–60.

As noted earlier, each of the process steps has specific energy requirements and consumption patterns, as well as various energy efficiency measures that can be applied to reduce energy use and increase productivity depending on the characteristics and conditions of the cement plant. This section profiles specific energy efficiency technologies and measures that are applicable to the Brazilian cement industry.

The team first developed a draft candidate list of technologies and measures to improve thermal and electric energy efficiency in the cement sector based on information contained in the Industrial Energy Technology Database, augmented by additional research and resources. The final list of priority technologies was determined in close coordination with the Brazilian counterpart based on four main factors: 1) applicability to the Brazilian cement sector, which is already quite energy-efficient, 2) level of potential fuel and electricity savings, 3) level of commercial development, and 4) cost-effectiveness. The group of priority technologies generally includes simpler and non-complex approaches to efficiency improvements, such as advanced control and automation systems, improved process optimization processes, variable speed drive installations, high-efficiency electrical motors, and optimization of air compression systems.

It should be noted that the technologies and measures detailed below are specific capital upgrades that can be evaluated for a facility and that may be applicable depending on the condition of current equipment, plant layout, site-specific conditions, and operating practices at the plant. In general, a number of basic operating and maintenance best practices and objectives should be implemented as basic operating principles for efficiency improvements, including:

- **Reduce kiln exit gas losses**
  - Install devices to provide better conductive heat transfer from the gases to the materials, for example, the kiln
  - Operate at optimal oxygen levels (control combustion air input)
  - Optimize burner flame shape and temperature
  - Improve or add additional preheater capacity
- **Reduce moisture absorption** opportunities for raw materials and fuels, avoiding the need to evaporate adsorbed water
- **Reduce dust in exhaust gases** by minimizing gas turbulence: dust carries energy away from the kiln where it is captured in dust collectors; the dust is recycled into the raw material and fed into the kiln where it is reheated
- **Lower clinker discharge temperature**, retaining more heat within the pyroprocessing system
- **Lower clinker cooler stack temperature**
  - Recycle excess cooler air
  - Reclaim cooler air by using it for drying raw materials and fuels or for preheating fuels or air
- **Reduce kiln radiation losses** by using the correct mix and more energy-efficient refractories to control kiln temperature zones
- **Reduce cold air leakage**
  - Close unnecessary openings
  - Provide more energy-efficient seals
  - Operate with as high a primary air temperature as possible
- **Optimize kiln operations** to avoid upsets.

## 2.1 RAW MATERIAL PREPARATION

### 2.1.1 HIGH-EFFICIENCY FANS AND VARIABLE SPEED DRIVES FOR MILL VENTS

#### TECHNOLOGY/MEASURE DESCRIPTION

Process fans are large electricity consumers in cement manufacture, second only to grinding. With better materials and design techniques for fans and with design optimization, fans with a higher operating efficiency are available for all cement industry applications. While also providing higher efficiencies, these modern fans are designed for higher wear resistance, lower material buildup and effects of erosion, better speed control, low vibration, and high operational stability. Fans with higher energy efficiency (82 to 84 percent) can replace inefficient process fans by both design and by retrofit of energy-saving speed control devices, eliminating the control damper. Under a systems approach, pressure drops in inlet and outlet duct systems can be analyzed and reduced by using computational fluid dynamics techniques, further improving fan system efficiencies.

Precise design specifications, reduced margins between requirement and capacity, and the use of appropriate control systems can offer a significant energy-saving opportunity. Optimum design margins for capacity and heat should not be greater than 10 percent, resulting in improved power consumption of up to 25 percent. To minimize this margin and offer precise process controls, the choice of an appropriate speed control device becomes essential. Speed control is the most effective means of capacity control in centrifugal equipment; the choice of the right speed control mechanism offers additional margins for efficiency improvements. Variable speed drives have been demonstrated to be the most suitable speed control mechanism, considering the precise control offered and the low inherent system energy losses.

Process fans, with efficiency levels of 82 to 84 percent and with an appropriate speed control mechanism, would be the preferred option for optimum energy efficiency in raw mills. Retrofits to replace low-efficiency fans with fans of higher operating efficiency, and the installation of appropriate speed control devices, are generally paid back by resulting energy savings.

#### ENERGY PERFORMANCE

Electrical energy consumption can be reduced by 0.36 kWh per ton of clinker.<sup>4</sup>

#### CAPITAL AND OPERATIONAL COSTS

Capital costs: \$0.04 per ton of clinker

Operational costs: \$0<sup>5</sup>

The specific costs of variable speed drives depend strongly on the size of the system. In Europe, for systems over 300 kilowatts (kW), the costs are estimated at €70 per kW (\$75 per kW) or less, and for systems in the range of 30 kW to 300 kW, the costs are estimated at €115 to €130 per kW (\$120 to \$140 per kW).<sup>6</sup> In India, the costs of high-temperature and low-temperature variable speed drives are assumed to be \$240 to \$300 per kW and \$120 to \$200 per kW, respectively. In India, the costs of high-efficiency fans are \$80 to \$120 per kW.<sup>7</sup>

#### FACTORS FOR IMPLEMENTATION

This is generally a retrofit measure. Layout constraints can pose certain barriers in some facilities, where the ideal duct system cannot be accommodated.

#### COST EFFECTIVENESS PRIORITY

High; however, applicability may be limited depending on the efficiency of current fan and vent systems. Economics also depends on the power price.

#### CASE STUDY

At Birla Vikas Cement Works, owned by Birla Corporation Limited, India, the older and inefficient raw mill vent fans were replaced by more-efficient fans, and variable speed

---

4 W. R. Morrow et al., *Assessment of Energy Efficiency Improvement and CO<sub>2</sub> Emission Reduction Potentials in India's Cement Industry* (Berkeley, CA: Lawrence Berkeley National Laboratory, 2013).

5 Ibid.

6 E. Worell and C. Galitsky, *Energy Efficiency Improvement and Cost Saving Opportunities for Cement Making: An ENERGY STAR® Guide for Energy and Plant Managers* (Washington, DC: 2008).

7 Cement Sustainability Initiative (CSI), *Existing and Potential Technologies for Carbon Emissions Reductions in Indian Cement Industry* (2013).

drives were installed to control the air volume. These reduced the energy consumption by 0.36 kWh per ton of clinker. The capital cost for the measure was around \$0.033 per annual ton of clinker capacity.<sup>8</sup>

## 2.1.2 PRE-GRINDING FOR BALL MILLS

### TECHNOLOGY/MEASURE DESCRIPTION

The main trends in grinding processes (encompassing all processes including raw material and fuel preparation and finish grinding) in the cement industry are toward higher efficiency, reduction of power consumption, and system simplicity. In the case of new orders (all processing) in 2010, vertical mills increased their share to over 60 percent, and ball mills fell below 30 percent.<sup>9</sup> In the case of raw material mills, the objectives are to grind and dry the raw materials and produce a homogenous raw meal from a number of components that are sometimes variable in themselves. The feed moisture contents are generally between 3 and 8 percent but sometimes are over 20 percent by weight. Raw grinding product fineness requirements are usually <10 percent to 15 percent residue on the 90 micrometer screen (<1 to 2 percent residue on the 200 micrometer screen), with feed particle sizes of 100 to 200 millimeters.

Traditional ball mills used for raw material grinding can be replaced by vertical roller mills or higher-efficiency roller mills, by ball mills combined with high-pressure roller presses, or by horizontal roller mills. Use of these advanced mills saves energy without compromising quality. Modern, efficient plants typically use vertical roller mills for raw material grinding; vertical roller mills represented 80 percent of all new raw material plants in 2008.<sup>10</sup> The advantage of vertical mills is their relatively low power consumption and the simultaneous grinding, drying, and separation in the mill itself, together with a wide mass flow control range of 30 to 100 percent. This mill type achieves a specific power requirement of below 10 kWh per ton at a medium raw

material hardness and a medium product fineness of 12 percent residue on a 0.09 millimeter screen.<sup>11</sup>

However, many ball mills remain in use in raw material grinding and are not candidates for complete replacement. Most ball mills have two chambers, for coarse and fine grinding. Grinding ball size and distribution are designed and adjusted considering, among others, raw material conditions and mill dimensions. However, the energy efficiency in the coarse grinding chamber is extremely poor, and there is a limitation to improving the performances for both coarse and fine grinding on the same mill by ball size selection. An effective approach to improve ball mill efficiency is to install a roller mill or roller press as a pre-grinder (for coarse grinding) and to use the existing ball mill exclusively for fine grinding. This approach improves specific energy consumption and can improve productivity between 30 and 50 percent.

### ENERGY PERFORMANCE

By adding pre-grinding, electricity consumption can be reduced by 8 kWh per ton of raw material (approximately 22 percent).<sup>12</sup> Others have reported electricity reductions in the range of 9 to 11 kWh per ton of raw material.<sup>13</sup>

Replacing older ball mills with vertical roller mills or high-pressure grinding rolls can reduce electricity consumption by 11 to 15 kWh per ton of raw material.

### CAPITAL AND OPERATIONAL COSTS

A Japanese installation of a pre-grinder increased the production capacity from 180 to 354 tons of raw material per hour and reduced specific grinding power consumption by 22 percent (~8 kWh). The installation cost of the system was \$7.3 million.<sup>14</sup>

8 United Nations Framework Convention on Climate Change, *Energy Efficiency Measures at Cement Production Plant in Central India*, CDM project design document, <http://cdm.unfccc.int/Projects/DB/SGS-UKL1175367790.14/view> (2007).

9 ZKG International, "Grinding Trends in the Cement Industry," [http://www.zkg.de/en/artikel/zkg\\_2010-04\\_Grinding\\_trends\\_in\\_the\\_cement\\_industry\\_886612.html](http://www.zkg.de/en/artikel/zkg_2010-04_Grinding_trends_in_the_cement_industry_886612.html) (2010).

10 Ibid.

11 Ibid.

12 Asia-Pacific Partnership on Clean Development and Climate (APP) Cement Task Force, *Energy Efficiency and Resource Saving Technologies in Cement Industry* (Washington, DC: 2009).

13 U.S. EPA, *Available and Emerging Technologies for Reducing Greenhouse Gas Emissions from the Portland Cement Industry* (Washington, DC: 2010).

14 APP Cement Task Force, *Energy Efficiency and Resource Saving Technologies in Cement Industry*.

Capital investment cost estimates for a complete ball mill replacement vary widely, but include one estimate of \$33 per ton of raw material.<sup>15</sup>

#### RELEVANT FACTORS FOR IMPLEMENTATION

Most applicable to older plants with raw grinding limitations and high power consumption. Feasibility of this measure depends on the age and performance of the existing ball mill. For mills that are older than a threshold (for example, 10 years is used in China), it may be more feasible to replace the ball mill with a new vertical mill. This measure will be more applicable for those plants where the replacement of the ball mill is not considered feasible and increased production is desired.

#### COST EFFECTIVENESS PRIORITY

Medium to low, depending on the total capital cost and the extent of productivity gains. Effectiveness also depends on the properties of the raw materials from the quarry and on the grindability of the raw mix components.

## 2.2 FUEL PREPARATION

### 2.2.1 HIGH-EFFICIENCY FANS AND VARIABLE SPEED DRIVES FOR MILL VENTS

#### TECHNOLOGY/MEASURE DESCRIPTION

Similar to the raw meal mills, the energy efficiency in coal mills also can be improved with the use of high-efficiency fans (in a dust collector bag fan) and variable speed drives for air flow control.

#### ENERGY PERFORMANCE

Electricity consumption can be reduced by 0.16 kWh per ton of clinker.

#### CAPITAL AND OPERATIONAL COSTS

Installation costs in India are reported to be \$0.04 per annual ton of clinker capacity.

#### COST EFFECTIVENESS PRIORITY

High; however, applicability may be limited depending on the efficiency of current fan and vent systems. Economics also depends on the power price.

## 2.3 CLINKER PRODUCTION

### 2.3.1 PROCESS CONTROLS AND OPTIMIZATION

#### TECHNOLOGY/MEASURE DESCRIPTION

The clinker-making process is a countercurrent process, with the kiln located between two heat exchangers that recover the heat of the combustion gases and the hot clinker. Optimum control of the kiln system is key for a smooth and energy-efficient process. Non-automated or non-optimum process control systems may lead to heat losses, unstable process conditions, and more operational stops. The latter effects lead to increased fuel demand of the system. Automated computerized control systems are effective measures to optimize combustion process and conditions and to maintain operating conditions in the kiln at optimum levels. Today, all modern kilns are equipped with such systems.

Both raw materials and the fuel mix can be improved through analysis of chemical and physical characteristics. Besides automating the weighing and blending processes, other parameters such as air and mass flow and temperature distribution can be controlled in order to optimize kiln operation. Additional process control systems include the use of online analyzers that permit operators to determine the chemical composition of raw materials and the product, thereby allowing for immediate changes in the blend of these materials. Process control of the kiln system can improve heat recovery, material throughput, and reliable control of free lime content in the clinker. As a result, the operating cost of an optimized kiln is usually reduced as a result of decreased fuel and refractory consumption, lower maintenance costs, and higher productivity.

Combustion management is of prime importance for kiln optimization and requires specific attention to the following items:

1. **Fuel grinding management:** fuel grinding should be managed to achieve optimally set fineness.
2. **Air ratio management:** to maintain an appropriate air ratio, the oxygen concentration in the combustion exhaust gas requires strict management.

---

<sup>15</sup> U.S. EPA, *Available and Emerging Technologies for Reducing Greenhouse Gas Emissions from the Portland Cement Industry*.



**Figure 3:** Schematic Depiction of Control Points and Parameters in a Kiln System Control and Management System

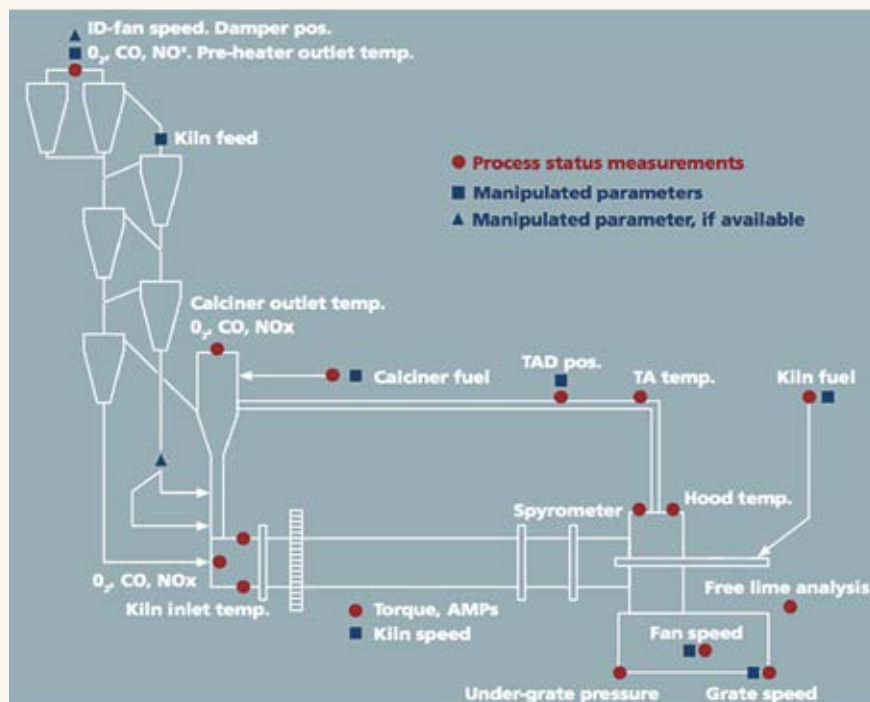

Source: FLSmidth.

3. **Exhaust gas management:** carbon dioxide and nitrogen oxides should be measured, and the measurement data should be used for combustion management.
4. **Kiln burner management:** the basic designs such as the fuel discharge angle of the burner, the primary air ratio, etc., should be reviewed to maintain the optimum combustion conditions.
5. **Cooler operation management:** heat recovery at the cooler greatly affects the combustion management of the kiln burner.

Improved process control also will help to improve the product quality and grindability, such as reactivity and hardness of the produced clinker, which may lead to more-efficient clinker grinding. A number of management systems are marketed through the cement industry manufacturers and are available and in use throughout the world. Most modern systems use so-called expert control (also known as “fuzzy logic” or rule-based control strategies). Expert control systems do not use a modeled process to control process conditions, but try to simulate the best human operator, using information from various stages in the process.

An alternative to expert systems or fuzzy logic is model-predictive control using dynamic models of the processes in the kiln. Additional process control systems include the use of online analyzers that permit operators to keep track of the chemical composition of raw materials being processed in the plant. This enables rapid changes to be made to the blend of raw materials. A uniform feed allows for steadier kiln operation, thereby saving fuel.

Modern versions of process control and optimization systems make use of advancements in information and communication technologies and enable real-time monitoring and adjustment of process parameters by multiple users using, among others, mobile devices.<sup>16</sup>

#### ENERGY PERFORMANCE

Thermal energy savings from process control systems may vary between 2.5 percent and 10 percent, and the typical savings are estimated at between 2.5 percent and 5 percent.<sup>17</sup>

<sup>16</sup> National Development and Reform Commission of China, *National Key Energy-Saving Technologies Promotion Directory* (Fifth Batch) (Beijing: 2012), 65.

<sup>17</sup> EU-China Energy and Environment Program, *Cement – A Reference Book for the Industry* (Brussels: 2009).

In addition, electricity consumption can be reduced by up to 1 kWh per ton of clinker.<sup>18</sup>

For kilns without a control system, savings can be between 50 and 200 megajoules (MJ) per ton of clinker.<sup>19</sup>

### CAPITAL AND OPERATIONAL COSTS

Capital costs are estimated at between \$0.34 million and \$0.47 million (for a plant with 2 million tons per year of production capacity).<sup>20</sup>

Operational costs can be reduced by \$0.3 to \$0.85 per ton of clinker in new plants and by \$0.36 to \$1.0 per ton of clinker in retrofitting cases.<sup>21</sup> Often, a simple payback period of two years is achievable for kiln control systems.

The economics of advanced process control systems are very good, and payback periods can be as short as three months. In general, the estimated payback period is less than two years.

### RELEVANT FACTORS FOR IMPLEMENTATION

- The existing plant constellation predetermines the further needs for equipment and consequently the implementation costs and system performance.
- A high educational level of operators and staff is critical for process control and optimization.
- Expert control systems simulate the best operator by using information from various stages in the process.
- Computational modeled predictions may be used for future applications.
- Electrically driven control fittings consume power.

### COST EFFECTIVENESS PRIORITY

High. There are no barriers to installing advanced process controls on new construction. Most existing facilities should be able to retrofit the operations to accommodate control

systems. However, given the high level of technology in Brazilian plants, the energy savings in general are likely to be on the lower side of the estimated range.

### CASE STUDIES

In a 4,500 ton per day Chinese plant, with the installation of a process control and optimization system, annual energy consumption was reduced by 395.6 terajoules. The installation required an investment of 980,000 Chinese renminbi and took one month to complete. The system provided annual savings of 8 million Chinese renminbi, resulting in a payback time of two months.

In another Chinese plant with 4,000 tons per day of production, annual energy consumption was reduced by 351.7 terajoules with the installation of a process control and optimization system. The system required an investment of 990,000 Chinese renminbi and took one month to install. The associated annual savings was 8 million Chinese renminbi, resulting in a payback time of 1.5 months.<sup>22</sup>

### 2.3.2 MODERN MULTI-CHANNEL BURNERS

#### TECHNOLOGY/MEASURE DESCRIPTION

Some cement kiln systems are equipped with direct-fired solid fuel systems that use a mono-channel burner pipe to the kiln. Mono-channel burners are basically a refractory-lined single pipe with a nozzle. Primary air and fuel are conveyed together through the mono-channel for combustion into the rotary kiln. These systems typically have primary air flow rates that are 20 to 40 percent of the total combustion air required. A mono-channel burner also has operational disadvantages: the exit speed obtains a fixed velocity at the tip of the burner by design of the nozzle diameter. The velocity cannot be adjusted during operation. Furthermore, shaping the flame by changing the burner adjustment is not possible during operation, if, for example, one wanted to optimize the temperature profile in the sintering zone.

State-of-the-art cement kiln systems use indirect-fired solid fuel systems that use multi-channel burners. The multi-channel burners give the kiln operator flame-shaping ability.

---

18 European Cement Research Academy (ECRA)/CSI, *Development of State of the Art-Techniques in Cement Manufacturing: Trying to Look Ahead* (Dusseldorf/Geneva: 2009).

19 Ibid.

20 Ibid.

21 Ibid.

---

22 National Development and Reform Commission of China, *National Key Energy-Saving Technologies Promotion Directory (Fifth Batch)* (Beijing: 2012), 65–66.

These systems typically have primary air flow rates that are 8 to 12 percent of the total combustion air required. The additional air (secondary air) required for combustion originates from the clinker cooler at 600 to 1,000 degrees Celsius (depending on cooler type and operation) and leads to the kiln and the calciner, respectively. If the primary air ratio is reduced by replacing, for example, a mono-channel burner with a multi-channel burner, a bigger share of hot combustion air can be taken from the cooler, leading to a decrease in specific fuel consumption.

Besides the energy-saving effect, modern multi-channel burners have several advantages related to kiln operation: nitrogen oxide emissions may be reduced due to the decreased oxygen availability in the core flame. Furthermore, these modern burners allow the use of significant amounts of secondary fuels.

#### ENERGY PERFORMANCE

Depending on the secondary air temperature, reduction of the primary air ratio by 5 to 10 percent will lead to a fuel energy saving of 50 to 80 MJ per ton of clinker at conventional kilns and about half of this at precalciner kilns. The electricity demand will remain more or less unchanged as the higher consumption for control fittings and air delivery channels can be offset by the reduction of the primary air.<sup>23</sup>

#### CAPITAL AND OPERATIONAL COSTS

If the existing system is a direct-fired system with a mono-channel burner, then the plant will be required to convert the direct-fired system to an indirect-fired system (or a variation of it) before changing to a multi-channel burner. The capital cost to convert a direct-fired system to an indirect-fired system can vary greatly depending on the plant conditions. The typical range can be between \$5 million and \$10 million.

If the existing system is an indirect-fired system with a mono-channel burner, then the plant retrofitting costs for Europe are estimated to be between \$0.54 million and \$0.68 million

(2009 figures). Figures for India are between \$0.2 million and \$0.4 million, depending on the plant capacity.<sup>24</sup>

Operational costs are expected to decrease by \$0.11 to \$0.34 per ton of clinker.<sup>25</sup>

#### COST EFFECTIVENESS PRIORITY

Low. Applicability may be limited given the high level of technology in the Brazilian industry. Adoption of low nitrogen oxide combustion techniques also limits savings potential.

### 2.3.3 LOW-PRESSURE DROP CYCLONES FOR SUSPENSION PREHEATERS

#### TECHNOLOGY/MEASURE DESCRIPTION

Multi-stage cyclone preheaters are the main components for the heat exchange of raw gas and raw meal in the clinker-burning process. Cyclones are used to preheat the raw meal prior to the kiln. Exhaust gases from the kiln or clinker cooler are routed to the cyclone and provide the heat to preheat the raw meal suspended or residing in the cyclone. The larger the pressure drop losses in the cyclone, the greater the energy requirements for the kiln or clinker cooler exhaust fan. Modern cyclones are designed with lower pressure drop and higher material separation efficiency than older designs. Plants with older design cyclones may be able to upgrade their preheater cyclones with modern design cyclones. By doing so, the static pressure at the preheater vent fan will decrease, resulting in potentially lower specific power consumption. In addition, the increased material separation efficiency will improve heat transfer in the preheater, thereby lowering the specific fuel consumption.

#### ENERGY PERFORMANCE

Depending on the efficiency of the fan, for each hectopascal of pressure loss reduction, 0.12 to 0.15 kWh of electricity can be saved per ton of clinker. For older-type kilns, this amounts to savings of 0.6 to 1.5 kWh per ton of clinker.

<sup>23</sup> Ibid.

<sup>24</sup> ECRA/CSI, *Development of State of the Art-Techniques in Cement Manufacturing*.

<sup>25</sup> Ibid.

## CAPITAL AND OPERATIONAL COSTS

Capital costs are estimated at between \$10.8 million and \$13.5 million (for a plant with 2 million tons per year of clinker capacity and including the replacement of three cyclone stages in a double-string preheater) (2009 values).

Operational costs are expected to decrease by \$0.068 to \$40.11 per ton of clinker.

## RELEVANT FACTORS FOR CONSIDERATION

Replacement with low-pressure drop cyclones can be economically reasonable when the foundation and tower of the preheater are usable without rebuilding. The costs of such refurbishment are very site-specific. The main parameters influencing the feasibility of this measure include:

- Efficiency and flow volume of the induced draft fan
- Need for extra capacity
- Temperature/number of cyclone stages
- Pressure drop and efficiency of existing cyclone stages
- Electricity price.

## COST EFFECTIVENESS PRIORITY

Low. Applicable to old plants. Replacement with low-pressure drop cyclones can be economically reasonable when the foundation and tower of the preheater are usable without rebuilding. The costs of such refurbishment are very site-specific.

## 2.3.4 WASTE HEAT RECOVERY FOR POWER PRODUCTION

### TECHNOLOGY/MEASURE DESCRIPTION

In the case of dry process cement plants, nearly 40 percent of the total heat input is available as waste heat from the exit gases of the preheater and clinker cooler. The quantity of heat from preheater exit gases ranges from 750 to 1,050 MJ per ton of clinker at a temperature range of 300 to 400 degrees Celsius. The quantity of heat from the clinker cooler ranges from 330 to 540 MJ per ton of clinker at a temperature range of 200 to 300 degrees Celsius from the exhaust air of the grate cooler. A portion (or in some cases all) of this heat is used to dry raw materials and coal. In certain cases, it may be cost effective to recover the

remaining portion of the heat in these exhaust streams for power generation.

Because raw material drying is important in a cement plant, heat recovery has limited application for plants with higher raw material moisture content. Often drying of other materials such as slag or fly ash requires hot gases from the preheater or cooler; in that case, opportunities for waste heat recovery will be further decreased.

Power production with residual hot gases from the preheater and hot air from the cooler require a heat recovery boiler and a turbine system. Power generation can be based on a steam cycle or an organic Rankine cycle (that is, the conversion of heat into work). In each case, a pressurized working fluid (water for the steam cycle or an organic compound for the organic Rankine cycle) is vaporized by the hot exhaust gases in a heat recovery boiler, or heater, and then expanded through a turbine that drives a generator.<sup>26</sup>

**Steam Rankine Cycle**—The most commonly used Rankine cycle system for waste heat recovery power generation, the steam Rankine cycle, uses water as the working fluid and involves generating steam in a waste heat boiler, which then drives a steam turbine. As shown in Figure 4, in the steam waste heat recovery cycle, the working fluid—water—is first pumped to elevated pressure before entering a waste heat recovery boiler. The water is vaporized into high-pressure steam by the hot exhaust from the process and then expanded to lower temperature and pressure in a turbine, generating mechanical power that drives an electric generator. The low-pressure steam is then exhausted to a condenser at vacuum conditions, where the expanded vapor is condensed to low-pressure liquid and returned to the feedwater pump and boiler.<sup>27</sup> The steam turbine technology is best known from power plants. While in modern power plants, electric efficiency is raised to 45 to 46 percent, the relatively low temperature level from the cooler (200 to 300

<sup>26</sup> A third type of Rankine cycle is based on a mixture of water and ammonia and is called the Kalina cycle. Application of the Kalina cycle to the cement industry is still in the demonstration phase.

<sup>27</sup> Institute for Industrial Productivity/International Finance Corporation (IIP/IFC), *Waste Heat Recovery for the Cement Sector: Market and Supplier Analysis* (Washington, DC: 2014).

**Figure 4:** Typical Waste Heat Recovery System Using Steam Rankine Cycle

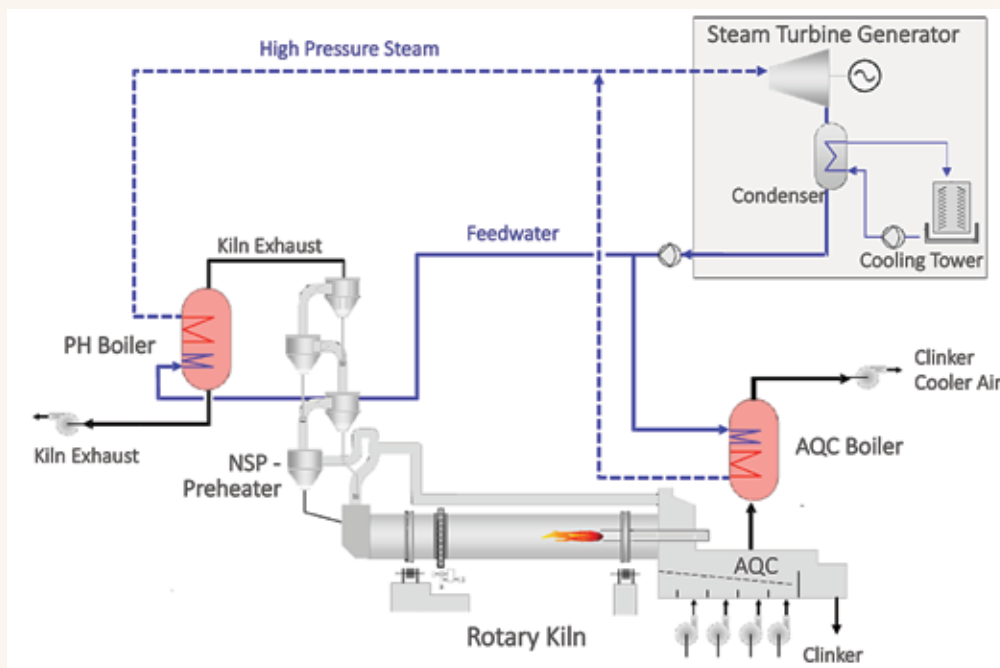

Source: Adapted from Holcim, 2012–2013.

degrees Celsius) limits the efficiency in waste heat recovery systems in cement kilns to a maximum of 20 to 25 percent.<sup>28</sup>

Steam cycles are, by far, the most common waste heat recovery systems in operation in cement plants. These systems are generally characterized by the following:

- Are most familiar to the cement industry and economically preferable where source heat temperature exceeds 300 degrees Celsius.
- Are based on proven technologies and simple to operate.
- Are widely available from a variety of suppliers.
- Are less costly to install than other systems on a specific cost basis (\$ per kW).
- Require higher-temperature waste heat to operate optimally (minimum >260 degrees Celsius); generation efficiencies fall significantly at lower temperatures, and lower pressure and temperature steam conditions can result in partially condensed steam exiting the turbine, causing blade erosion.

- Can recover heat from the middle of the air cooler exhaust flow to increase waste gas temperatures to an acceptable level for the system, but at the expense of not recovering a portion of cooler waste heat.
- Often require a full-time operator, depending on local regulations.
- Require feedwater conditioning systems.
- Require a water-cooled condenser; air-cooled condensers can be used but create a performance penalty due to higher condenser vacuum pressures.
- Match well with large kilns and systems with low raw material water content (resulting in higher waste gas temperatures).<sup>29</sup>

**Organic Rankine Cycle**—Other types of working fluids with better generation efficiencies at lower heat-source temperatures are used in organic Rankine cycle (ORC) systems. ORC systems typically use a high-molecular-mass organic working fluid such as butane or pentane that has a lower boiling point, higher vapor pressure, higher molecular mass, and higher mass flow compared to water. Together,

<sup>28</sup> CSI, *Existing and Potential Technologies for Carbon Emissions Reductions in Indian Cement Industry*.

<sup>29</sup> IIP/IFC, *Waste Heat Recovery for the Cement Sector*.

these features enable higher turbine efficiencies than those offered by a steam system. ORC systems can be used for waste heat sources as low as 150 degrees Celsius, whereas steam systems are limited to heat sources greater than 260 degrees Celsius. ORC systems typically are designed with two heat transfer stages. The first stage transfers heat from the waste gases to an intermediate heat transfer fluid (for example, thermal transfer oil). The second stage transfers heat from the intermediate heat transfer fluid to the organic working fluid. ORCs have commonly been used to generate power in geothermal power plants, and more recently, in pipeline compressor heat recovery applications in the United States. ORC systems have been widely used to generate power from biomass systems in Europe. ORC system's specific features include the following:

- Can recover heat from gases at lower temperatures than is possible with conventional steam systems, enabling ORC systems to use all recoverable heat from the air cooler.
- Operate with condensing systems above atmospheric pressure, reducing risk of air leakage into the system and eliminating the need for a de-aerator.
- Are not susceptible to freezing.
- Operate at relatively low pressure, meaning that they can operate unattended and fully automated in many locations depending on local regulations.
- Avoid blade erosion because the organic fluid properties result in the working fluid remaining dry (no partial condensation) throughout the turbine.
- Can use air-cooled condensers without negatively impacting performance.
- Have a lower-speed (rpm) turbine, which allows for generator direct drive without the need for and inefficiency of a reduction gear.
- Utilizes equipment (turbines, piping, condensers, heat exchanger surface) that is typically smaller than that required for steam systems, and the turbine generally consists of fewer stages.
- Are typically applied to lower-temperature exhaust streams, although ORC systems can provide generation efficiencies comparable to a steam Rankine system.

They are limited in sizing and scalability and generally are smaller in capacity than steam systems.

- Depending on the application, often have a higher specific cost (\$ per kW) than steam systems.
- Create some system inefficiencies related to the two-stage heat transfer process.
- Normally use heat transfer fluids and organic fluids that are combustible, requiring fire protection measures and periodic replacement over time. Also, there may be environmental concerns about potential system leaks.
- Are generally well-matched with small- to medium-size, high-efficiency kilns or kilns with elevated raw material moisture content.<sup>30</sup>

Japanese companies spearheaded the introduction of waste heat recovery power systems in the cement industry and introduced the technology to China in 1998. Since then, China has become the market leader in waste heat recovery installations in the number of systems installed domestically (see Figure 5) and in the number of systems installed internationally by Chinese companies (particularly in Asia). Initially, waste heat recovery development in China was driven by incentives such as tax breaks and Clean Development Mechanism (CDM) revenues for emissions reductions from clean energy projects. In 2011, a national energy efficiency regulation mandated waste heat recovery on all new clinker lines built after January 2011. These drivers were reinforced when multiple Chinese waste heat recovery suppliers entered the market, lowering waste heat recovery capital and installation costs by adopting domestic components and design capability, which developed the technology for the Chinese market. The experience in China on waste heat recovery for cogeneration of power has shown that, in large plants, about 22 to 36 kWh per ton of clinker (25 to 30 percent of the total requirement) can be generated. This power is considered sufficient to operate the kiln section on a sustained basis.<sup>31</sup>

---

<sup>30</sup> Ibid.

<sup>31</sup> CSI, *Existing and Potential Technologies for Carbon Emissions Reductions in Indian Cement Industry*.

**Figure 5: Waste Heat Recovery Installations in the Cement Industry**

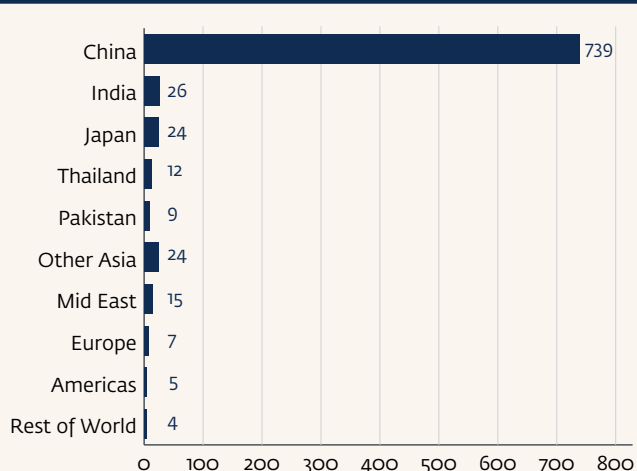

Source: OneStone Research, "Latest Waste Heat Utilization Trends," *CemPower*, 2013.

In part due to market experience in China, interest in cement industry waste heat recovery is expanding among countries and global companies, driven by the following:

- Rising prices for power and fuel, particularly where captive power plants prevail.
- Concerns about grid power reliability, particularly in developing countries where the electricity supply often is controlled by local, state-owned monopolies and the cost of power can represent up to 25 percent of the cost of cement manufacture.
- Industry commitment to and government support for sustainable development.

However, in many other regions with unstable power supplies, conventional self-generation solutions, such as captive diesel generators and captive thermal power stations, still can be preferred to waste heat recovery systems. The generation efficiency of waste heat recovery is normally less than 15 percent. If higher power production is needed, waste heat recovery is in competition with other energy efficiency measures for clinker production, but ultimately both techniques are aimed at a minimization of unused waste heat. Power generation can be further increased by additional co-firing into the boiler or by operating the kiln system with fewer cyclone stages or bypassing upper stage(s).

## ENERGY PERFORMANCE

Power generation potential is up to 22 kWh per ton of clinker; based on the chosen process and kiln technology, 8 to 10 kWh per ton of clinker can be produced from cooler exhaust air, and 9 to 12 kWh per ton of clinker can be produced from the preheater gases if the moisture content in the raw material is low and if it requires only a little hot gas/air for drying. Thus, in total, up to 22 kWh per ton of clinker, or up to 25 percent of the power consumption of a cement plant, can be produced by using these technologies without changes in kiln operation. If kiln operation is modified in order to produce more electricity (higher preheater exit gas and cooler exhaust air temperature), up to 30 kWh per ton of clinker is possible. Power generation can be further increased by additional co-firing into the boiler or by modification of the kiln system (for example, fewer cyclone stages or bypassing upper stage(s)). Output up to 45 kWh per ton of clinker has been reported. Depending on local conditions, this can be an attractive option. Under certain conditions, it also can make sense to use the residual energy content of the gases after waste heat recovery for cooling purposes.<sup>32</sup>

The experience in China on waste heat recovery for cogeneration of power has shown that, in large plants, about 22 to 36 kWh per ton of clinker (25 to 30 percent of the total requirement) can be generated. This power is considered sufficient to operate the kiln section on a sustained basis.<sup>33</sup>

There will be marginal increases in power consumption of the preheater fan and cooler fan due to the additional pressure drop of the boilers.

## CAPITAL AND OPERATIONAL COSTS

A waste heat recovery installation is a relatively complex system with multiple interrelated subsystems. The basic package for a steam-based system consists of heat recovery boilers or heat exchangers, a steam turbine, a gearbox, an electric generator, a condenser, steam and condensate piping,

<sup>32</sup> ECRA/CSI, *Development of State of the Art-Techniques in Cement Manufacturing*.

<sup>33</sup> CSI, *Existing and Potential Technologies for Carbon Emissions Reductions in Indian Cement Industry*.

lubrication and cooling systems, a water treatment system, electrical interconnection equipment, and controls.

The total installed cost, which includes design, engineering, construction, and commissioning, can vary greatly depending on the scope of plant equipment, country, geographical area within a country, competitive market conditions, special site requirements, and availability of a trained labor force and prevailing labor rates.

The total capital cost (equipment and installation) is a strong function of size: smaller waste heat recovery systems will have a higher dollar cost per kilowatt of generation capacity. Engineering, civil work, and construction costs can represent as much as 34 to 45 percent of the total project cost. Costs in Western countries are at the high end of the range.

Figure 6 shows industry estimates of total installed costs for cement waste heat recovery projects on a \$ per kW of electricity basis and illustrates how costs depend heavily on project size (in megawatts, MW), local cost variations (region of the installation), and type of technology (systems lower than 2 to 3 MW tend to be ORC systems). Hence, total installed costs for waste heat recovery systems are a function of all of the factors mentioned above, but costs can range from \$7,000 per kW of electricity for 2 MW systems (ORC) to \$2,000 per kW of electricity for 25 MW systems (steam).<sup>34</sup>

34 IIP/IFC, *Waste Heat Recovery for the Cement Sector*.

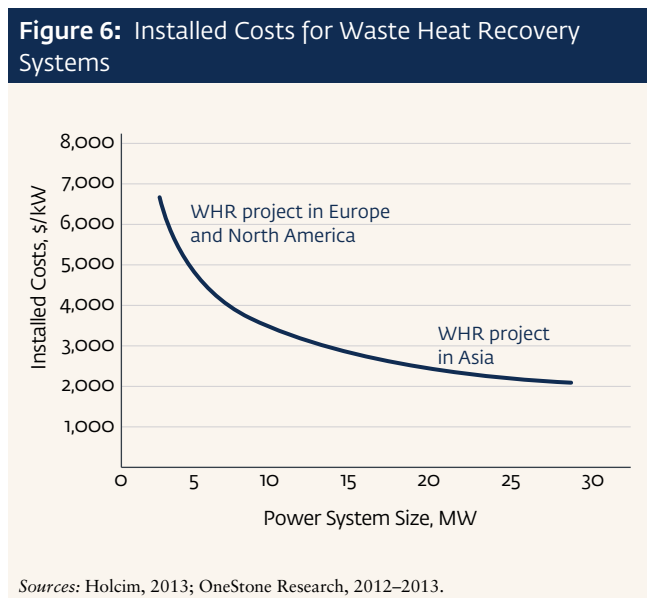

Chinese suppliers now have greater experience in engineering, constructing, and commissioning steam-based waste heat recovery projects and have substantially reduced the cost of waste heat recovery systems within China, where project costs for these systems are now three to four times lower than costs of systems installed in Western countries using Western suppliers. Chinese technologies are increasingly available in Asian and European markets. Figure 7 shows the relative cost differences for Chinese waste heat recovery systems in China, Asia, and Europe.

In India, the installation costs are estimated to range between \$1.6 million and \$2 million per MW of capacity.<sup>35</sup>

### RELEVANT FACTORS FOR IMPLEMENTATION

The following factors are important in determining the applicability of this measure:

- The amount of heat available in the waste gases (exhaust gas volume and temperature) and the conditions of the waste gases determine the size, potentially the technology (for example, ORCs are more applicable for lower-temperature exhaust streams and lower gas volumes), and overall generation efficiency (for example, the amount of power that can be produced) of the waste

35 IIP/IFC, *Waste Heat Recovery for the Cement Sector*.

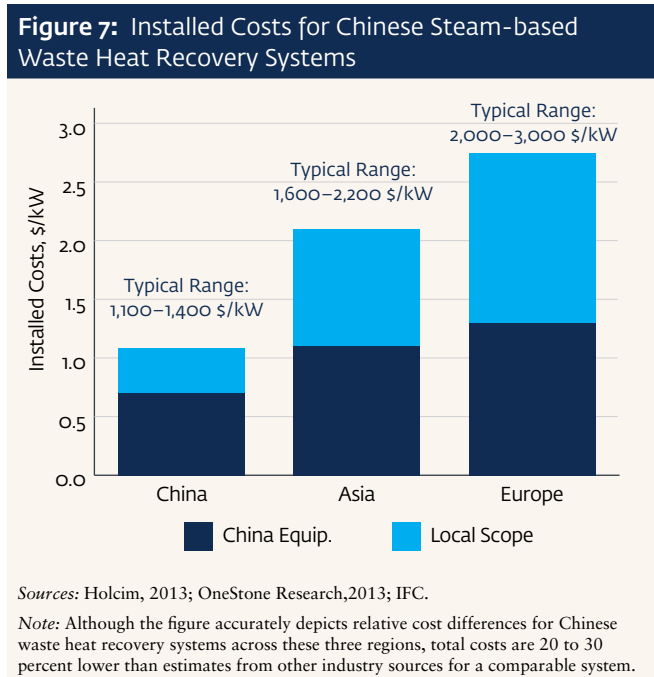



heat recovery system. The amount of heat available and at what temperature is a function of the size and configuration of the kiln (that is, tons per day and the number of preheater stages) and the raw material moisture level.

- Capital cost of the heat recovery system is generally a function of size, technology, and supplier.
- System installation costs (design, engineering, construction, commissioning, and training) are functions of the installation size, technology, complexity, supplier, and degree of local content.
- System operating and maintenance costs are a function of size, technology, and site-specific operational constraints or requirements; costs are influenced by staffing: whether the system will be handled by existing operating staff or by new staff that require training, or operations will be outsourced.
- Operating hours of the kiln and availability of the heat recovery system.
- Displaced power prices based on grid electricity no longer purchased, or reduced dependence on captive power plants and associated costs.
- Net power output of the waste heat recovery system. Net output is more important in determining project economics than gross power output. The impact of auxiliary power consumption and process/booster fans must be included in efficiency and economic calculations.
- Availability of space in close proximity to the preheater, cooler, and air-cooled condensers.
- Availability of water.

#### **COST EFFECTIVENESS PRIORITY**

Medium. Economics depends on prevailing power prices and on the amount of available heat after all current requirements (for example, raw material and fuel drying) are met. Waste heat recovery projects are capital intensive.

#### **CASE STUDIES**

There are close to 900 waste heat recovery power installations in the world. As previously shown in Figure 5, China leads in the number of waste heat recovery installations by a wide

margin, followed by India and Japan. Conventional steam system technology accounts for 99 percent of existing waste heat recovery installations (among an estimated 865 such systems installed in the cement industry worldwide in 2012, only 9 were ORC and only 2 were Kalina cycle systems). Primary interest in non-steam systems has been in Europe and the United States, where kiln efficiencies tend to be higher and clinker line capacities are smaller. ORC and Kalina cycle units offer higher power efficiencies as kiln efficiencies increase and exhaust temperatures decrease. Packaged ORC turbo generators are available in less than 1 MW size.

Most large global cement firms are using waste heat to power systems in some of their facilities. For example, Holcim experimented early with waste heat recovery, commissioning units in 1982 and 1994. Holcim began installing commercial units in 2006, and, as of 2013, the company had 271 MW of waste heat recovery power capacity, including 53 MW outside of China. Over the last five years, Holcim has initiated nine waste heat recovery projects in Canada, China, India, Lebanon, Romania, Slovakia, Switzerland, Thailand, and Vietnam. Most Holcim projects in Asia are steam cycle systems; most projects outside of Asia are ORC systems. As of the end of 2013, Lafarge, Heidelberg Cement, and Cemex had all installed or were in the process of installing a limited number of waste heat recovery power generation systems.

While most existing waste heat recovery systems are steam-based, a number of ORC systems have been installed on cement kilns. Ormat Incorporated, a leading ORC supplier for geothermal applications, operates two ORC systems in cement plants: a 1.2 MW system installed in 1999 at the Heidelberg Cement plant in Lengfurt, Germany, which recovers heat from the clinker cooler vent air; and a 4.8 MW unit located at AP Cement (now Ultra Tech Cement) in Tadipatri, Andhra Pradesh, India. Turboden (acquired by Mitsubishi in 2012) installed its first cement industry ORC system (2 MW) at Italcementi's Ait Baha plant in Morocco in 2010 (a 5,000 ton per day clinker line). In 2012, Turboden installed a 4 MW unit at a Holcim Romani plant in Alesd (a 4,000 ton per day clinker line); Turboden also has systems under construction at Holcim Slovakia (5 MW at a 3,600 ton per day line at the Rohoznik plant) and at

an undisclosed North American plant (7 MW). Holcim is installing another 4.7 MW ORC system at its Mississauga, Canada, plant from an undisclosed provider. ABB installed a 1.9 MW ORC system at Holcim’s Untervaz, Switzerland, plant using heat from the preheater.

**2.3.5 OXYGEN ENRICHMENT TECHNOLOGY**

**TECHNOLOGY/MEASURE DESCRIPTION**

Oxygen enrichment is the process of injecting oxygen (as opposed to air) directly into the combustion zone (or as an adjunct to the combustion air stream) to increase combustion efficiency, reduce exhaust gas volume, and reduce the available nitrogen that may form nitrogen oxides. In general, the use of oxygen-enriched combustion air reduces fuel consumption, increases production capacity, and can enhance the substitution of fossil fuels with low-caloric-value or alternative fuels.

Potential drawbacks of the measure include increased risk of damage to the kiln refractory and the potential for higher nitrogen oxide emissions if not adequately controlled due to increasing thermal nitrogen oxide formation in the sintering zone. Moreover, production of oxygen requires significant additional power consumption.

Oxygen enrichment technology is implemented in some cement plants in order to increase production capacity. In addition to specific fuel savings, experience with oxygen injection has demonstrated benefits ranging from production increases of up to 25 percent, reduced specific dust losses, and improved kiln stability, as evidenced by clinker quality and kiln coating (see Table 2).

**Table 2: Production Gains Achieved in Different Plants Using Oxygen Enrichment Technology**

Company	Base Production (tons per day)	New Production (ton per day)	% Increase
A	1,300	1,490	15
B	4,000	4,360	9
C	3,800	5,000	32
D	2,000	2,140	7

*Source: Air Products.*

In response to increasing pressure to lower fuel costs, cement producers have been very successful in increasing alternative fuel use to meet cost reduction goals. In many European markets, alternative fuels have replaced on average more than 50 percent of the fuel input, with some plants averaging 60 to 70 percent (see Table 3). The use of high alternative fuel rates in the calciner is common, and some plants have been very successful with the near-complete replacement of fossil fuels. However, the properties of these fuels have posed challenges for the pyroprocessing section in the kiln.

Preheater kilns that require firing most, if not all, fuels through the main burner are especially prone to issues associated with expanded use of alternative fuels such as a cool burning zone, an unstable and/or long flame, insufficient burnout, and high process variability. Such problems may ultimately result in poor clinker quality and kiln capacity. These adverse effects limit the possibilities for further increasing the use of alternative fuels. Oxygen enrichment also can be used to enhance stable and consistent combustion of low-quality alternative fuels with low heating value and larger particle size. The injection of oxygen into the flame root has proven to be very effective for these fuels as it enables more rapid heat-up, fuel devolatilization, and fuel ignition. The improved combustion conditions can compensate for flame cooling due to fuel moisture. In addition, the available residence time in the flame is used more effectively, which enhances burnout of fuels with larger particles. This is a concern for clinker quality and clinker sulfur retention if the larger particles fall into the clinker bed, and results in locally reducing conditions.

One frequently voiced concern about oxygen injection is the impact on nitrogen oxide emissions, due to increased thermal nitrogen oxide formation. This can be avoided if the oxygen injection system is designed correctly. In the case of oxygen injection for alternative fuel combustion, the oxygen raises combustion temperatures in the fuel-rich flame core where the overall fuel rich conditions favor the reduction of nitrogen oxide to nitrogen. This effect has been successfully exploited using oxygen injection for nitrogen oxide reduction in the power industry. In addition, the injection of oxygen into the flame compensates the cooling effects of moisture addition from the additional alternative fuel. Thus, oxygen brings the

**Table 3: Improvements in Alternative Fuel Use with the Use of Oxygen Enrichment**

	Plant							
	A	B	C	D	E	F	G <sup>a</sup>	H
% alternative fuel usage without oxygen	45.4	31.1	45.9	44.3	42.8	43.9	60.5	27.0
% alternative fuel usage with oxygen	72.9	52.4	69.3	65.6	77.3	58.3	67.0	40.7
% reduction in fossil fuel	-50.0	-25.9	-40.0	-36.0	-57.5	-25.0	-10.8	-22.0
CO <sub>2</sub> e savings (tons per year) <sup>b</sup>	13,500.0	8,100.0	10,800.0	9,720.0	34,500.0 <sup>c</sup>	10,800.0	3,780.0	11,880.0

Source: Air Products.

a. Production rates were held constant except for Plant G where there was a 4% production increase with oxygen.

b. Results are from recent installations (since 2009).

c. Carbon dioxide equivalent (CO<sub>2</sub>e) savings at Plant E were greater due to the substitution of biomass fuels for fossil fuel.

thermal condition in the burning zone back to where they are required to be for high-quality clinker production.

While additional production may not be a primary goal of oxygen use for alternative fuels, the reduced flue gas volume can compensate for the water ballast that negatively impacts the capacity of the flue gas system. Thus, lost production can be recovered, or, if desired, clinker production can be increased by combining the goals of alternative fuel increase and production increase.

Oxygen use has proven to be flexible and straightforward from an operational point of view. Kiln operators quickly realize the potential to stabilize the combustion during kiln upsets. Experience indicates that oxygen often promotes better kiln coating, as the temperature distribution in the burning zone is favorably affected by the additional flame stability. None of the applications has led to a reduction in refractory life, and many kilns have benefited from a stronger coating.<sup>36</sup>

### ENERGY PERFORMANCE

Thermal energy consumption can be reduced by 100 to 200 MJ per ton of clinker.

Electricity consumption can increase by 10 to 35 kWh per ton of clinker due to oxygen production.<sup>37</sup>

<sup>36</sup> Global Cement, “Oxygen-enhanced Combustion of Alternative Fuels,” <http://www.cemfuels.com/articles/320-oxygen-enhanced-combustion-of-alternative-fuels> (February 2, 2011).

<sup>37</sup> ECRA/CSI, *Development of State of the Art-Techniques in Cement Manufacturing*.

### CAPITAL AND OPERATIONAL COSTS

Both new installation and retrofit costs are estimated to be \$6.75 million to \$13.5 million (for a plant with 2 million tons per year of capacity and assuming a cryogenic air separation unit).

Operational costs are estimated to increase by \$0.68 to \$2.70 per ton of clinker (only considering increased electricity and reduced primary fuel consumption; kiln capacity improvements and increased ability to burn secondary fuels are not taken into consideration).<sup>38</sup>

Studies have shown that an increase of 25 to 50 percent in kiln capacity is possible with oxygen enrichment of 30 to 35 percent by volume.<sup>39</sup>

### RELEVANT FACTORS FOR IMPLEMENTATION

The decision for a dedicated oxygen supply system (on-site/off-site) depends on the specific need of the cement plant. Oxygen production itself leads to comparatively high additional power consumption. Other factors for consideration include:

- Integration of energy flows between the additional air separation unit and the cement plant. Further development of oxygen supply technology has an influence on the process and financial conditions.

<sup>38</sup> Ibid.

<sup>39</sup> U.S. EPA, *Available and Emerging Technologies for Reducing Greenhouse Gas Emissions from the Portland Cement Industry*.

- Durability of refractory lining and wear elements.
- Economics are ruled by power price and investment costs.

#### COST EFFECTIVENESS PRIORITY

Low to medium. May be useful for plants that need additional capacity or want to maximize alternative fuel use. An oxygen source is required, and dedicated air separation plants are capital intensive. Increased electricity use for oxygen production must be included in the plant energy balance.

#### CASE STUDY

The injection of oxygen to increase the use of alternative fuels was implemented at Lafarge’s Karsdorf plant in Germany in 2008. The plant has three kilns, of which kiln lines three and four are fourstage cyclone preheater kilns with a nominal daily production of 2,000 tons per day. These kilns fire-dried lignite dust, low-quality waste oils, animal meal, and shredded plastic fluff in the main burner and whole tires through the feed shelf. To allow for higher chlorine input resulting from alternative fuel combustion, each kiln was retrofitted with a 5 percent bypass.

The oxygen is produced cryogenically and is injected via a proprietary stainless steel lance through the burner into the flame root and through a second lance installed in the kiln hood. The lance in the kiln hood is installed to maximize oxygen injection flexibility for both improving the alternative fuels rate and increasing production. Initial optimization of the oxygen injection system had the following goals:

- Increase of solid alternative fuel (fluff)
- Minimization of dried lignite use
- Maximization of tire use
- Maintenance of the clinker quality.

Recovery of the approximately 10 percent production capacity that was lost due to the combustion of alternative fuels was desirable. The reduction of the fuel costs as the main purpose of the oxygen injection is reflected in these goals. The baseline condition and the typical fuel mix arrived after optimization are shown in Table 4.

**Table 4:** Impact of Oxygen Injection on Alternative Fuels and Production

	Baseline	With oxygen injection
Total alternate fuel rate (% heat input)	66%	75%
Liquids AF	36%	21%
Plastic fluff	21%	35%
Other AF	9%	9%
<b>Production</b>	<b>100%</b>	<b>105%</b>

Source: Global Cement, “Oxygen-enhanced Combustion of Alternative Fuels.”

Even at the baseline conditions, the plant already was using an impressive 66 percent alternative fuel. As Table 4 shows, these were mostly liquid alternative fuels. Although these liquids usually combust very well due to their high volatile content, general availability (at a reasonable cost) did not allow a further increase of this fuel group. Instead, with injection of oxygen, the amount of low-cost fluff could be increased significantly. The percentage of tires and animal meal stayed nearly constant. However, overall economic success of the oxygen injection is due mainly to the reduction of heat input from dried lignite from 34 percent to 25 percent, as this fuel is clearly the most expensive.

In addition to the installation of the oxygen delivery system, only a few minor changes were necessary to make the above possible. The original kiln control approach had to be modified, as it did not allow the reduction of lignite as the control fuel below a certain minimum value, and the fluff dosing system had to be upgraded to allow higher flow rates. Apart from permitting considerations, further increase of alternative fuels will likely face the following process restrictions:

1. Further decrease of dried lignite will remove the major source of sulfur for the clinker. This would require a new low-cost sulfur source to be added to the fuel mix.
2. Further increase of fluff will result in additional chlorine to the system. The current bypass design is at its limit. While this restriction can be removed, it would require further investment.

These plant-specific limits to a further increase of alternative fuels are only an example. Each kiln has specific challenges that require careful consideration as to whether oxygen is beneficial for production costs.<sup>40</sup>

## 2.4 CLINKER COOLING

### 2.4.1 OPTIMIZING HEAT RECOVERY

#### TECHNOLOGY/MEASURE DESCRIPTION

The clinker cooler cools the clinker discharged from the kiln down to an ideal temperature range of 100 to 150 degrees Celsius. The design of clinker coolers has evolved significantly over time. In the past, rotary coolers, planetary coolers, and older-design grate coolers were used. Today, the modern clinker cooler features a static inlet section followed by a deep clinker bed section (or sections). Air is passed through the clinker bed to cool the clinker and preheat the secondary and tertiary air for combustion. The clinker conveying method and air control methods vary from one vendor to another.

Clinker cooler optimization aims to maximize heat recovery, minimize clinker temperature, and reduce specific fuel consumption. This also may improve product quality and emission levels. Heat recovery can be improved through reduction of excess air volume, control of clinker bed depth, and new grates such as ring grates. Control of cooling air distribution over the grate may result in lower clinker temperatures and high air temperatures. A recent innovation in clinker coolers is the installation of a static grate section at the hot end of the clinker cooler. Additional heat recovery results in reduced energy use in the kiln and precalciner, due to higher combustion air temperatures.

All coolers heat the secondary air for the kiln combustion process and sometimes also heat tertiary air for the precalciner, using the highest-temperature portion of the remaining air. Grate coolers use electric fans and excess air. Rotary coolers and planetary coolers do not need combustion air fans and use little excess air, resulting in relatively lower heat losses. Optimization of heat recovery in coolers aims to maximize the amount and temperature

of secondary air and to reduce clinker temperature. While reducing fuel consumption, optimized heat recovery also may improve product quality and emission levels.

Proper burner pipe positioning is one way of improving cooler operation. Today's low-fuel-consuming kiln systems have low combustion air requirements, resulting in high secondary air temperatures and slower clinker cooling. In such systems, positioning the burner tip approximately 1 to 2 meters into the kiln—as opposed to positioning it at the kiln nose or even into the kiln hood as practiced in older-generation kilns—improves the kiln's own heat recuperating and cooling zone. This way, pre-cooled clinker drops at a lower temperature into the cooler, and the secondary air temperature drops. The clinker can be cooled quickly and reaches the latter clinker cooler zones at a lower temperature, resulting in lower clinker discharge and vent temperatures. Reduced need for cooling air reduces the load on the vent air system and saves considerable electricity. While improving the overall cooler thermal efficiency, the cooler also runs at a higher availability, and maintenance costs are reduced. However, pushing the burner into the kiln requires the use of extremely high-strength refractories on burner pipes in very severe applications.

Reducing primary air use and air infiltration rates at the kiln discharge maximizes the amount of secondary air. Low primary air rates are possible with semi-direct and indirect firing systems, offering primary air rates as low as 6 percent. Low air infiltration rates, on the other hand, can be accomplished with good hood sealing and an effective kiln discharge seal. Leaf-type kiln discharge seals, where overlapping sheets of high-quality steel ride on the kiln cowling, is an effective way of reducing infiltration. In kiln systems with a precalciner, any potential opening to ambient air between the calciner and the cooler—such as inspection doors, material discharge flaps, damper housings on tertiary air ducts, and kiln material inlet seal and kiln riser poke holes—should be kept as tight as possible.

Optimized distribution of both the clinker bed and the cooling air are also critical. Particularly in larger-diameter kilns, getting an even clinker distribution can be a challenge; the over-concentration of fine clinker particles poses a particular

---

<sup>40</sup> Global Cement, "Oxygen-enhanced Combustion of Alternative Fuels."

problem. The air flow can be improved by narrowing the cooler grate area on the fine clinker side, slowing the movement of the fine clinker bed, and diverting more fine clinker to the coarse cooler side by using wedge-type grates.

To avoid heavy air channeling and bypassing the clinker load, some air holes can be blanked off and cooling air thus can be diverted into the clinker load. When severe “red river” conditions exist and loss of cooler grates is experienced, “Ondufin” grates, which have cooling fins on the underside and which can stay cooler and last longer, can be applied. A proper and uniform distribution of the clinker on the grate is of importance and can be achieved by: 1) using a sloped inlet; 2) using a water-cooled, adjustable steel impact inlet plate; 3) reducing the effective grate width (horseshoe pattern of inlet grate plates); 4) using stationary quench grates at the front of the cooler; and 5) using a spreader beam across the cooler. An example of a fixed cooler inlet is shown in Figure 8.

Increasing the clinker bed thickness generally improves the overall clinker distribution and heat transfer. In addition, lower grate speed has had a positive effect on grate wear rates. High under-grate pressures and airflows adversely affect the conveying action of a reciprocating grate. To prevent clinker from flowing forward, the single grate surface should be at least horizontal. Best results can be attained with a maximum of 4.7 to 5.5 kilopascal under-grate pressures in horizontal

and 3-degree inclined coolers, and 2.0 to 2.5 kilopascal in old 10-degree inclined coolers.

Careful adjustment of airflow rate is another critical parameter, as both too little and too much air has undesirable consequences. To achieve this goal, predefined amounts of cooling air need to be established for every cooler compartment. Coolers with air beams or mechanical air flow regulators can refine the air distribution even more to sections of grate plates or to individual plates. Figure 9 shows a chart of optimized cooling air distribution for a typical eight-compartment reciprocating grate cooler—where the first five compartments (including the quench compartment) supply secondary air and tertiary air, if applicable, and compartments five through eight cool the clinker to a final temperature of approximately 100 degrees Celsius.<sup>41</sup> Modern automation systems employ high-temperature, high-sensitivity radar transmitters that allow precise measurement of the clinker bed depth and adjust the cooling air flow rate and grate speed accordingly to achieve optimal performance.<sup>42</sup>

41 E. H. Steuch, “Clinker Coolers,” in Bhatti et al., eds., *Innovations in Portland Cement Production* (Skokie, IL: Portland Cement Association, 2004), 477–98.

42 Toshniwal Industries Pvt. Ltd., “Clinker Cooler Optimization,” <http://www.tipl.com/blog/70-clinker-cooler-optimization.html>, viewed April 4, 2016.

**Figure 8:** Fixed Static Inlet Section for a Clinker Cooler

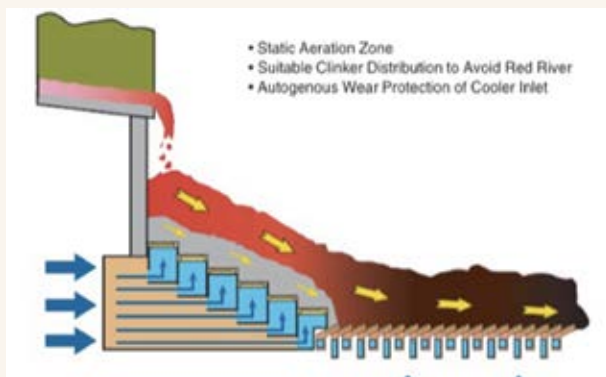

Source: Steuch, E.H. 2004. “Clinker Coolers,” Chapter 3.8, page 495 In *Innovations in Portland Cement Production* page 498.

**Figure 9:** Optimized Cooling Air Distribution for a Typical Eight-compartment Reciprocating Grate Cooler

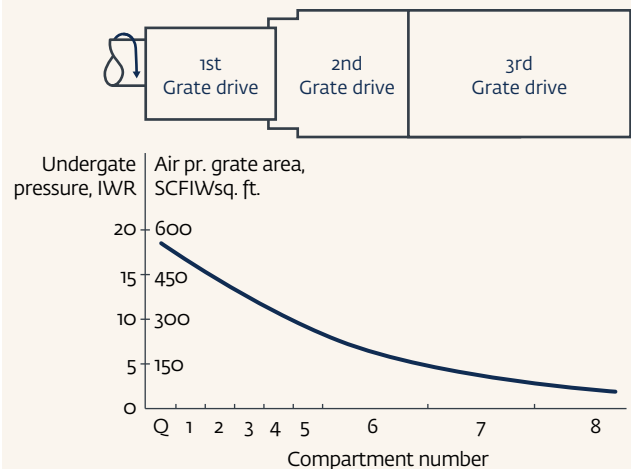

Source: Steuch, E.H. 2004. “Clinker Coolers,” Chapter 3.8, page 495 In *Innovations in Portland Cement Production* page 495.

In some older coolers where individual cooling fans serve multiple compartments, the distribution of air into each compartment is difficult, since the cooling air will try to migrate into the compartment with the lowest under-grate pressure—particularly when heavy loads travel down the cooler. Employing one air fan for each compartment and making sure that the compartments are well air-sealed from each other will result in a lower overall clinker discharge temperature and less air use. Where drag chains are located below the cooler, the best sealing is accomplished with flap valves controlled by level indicators located in the under-grate compartment. It also is important to avoid the mixing of low-temperature back-end air with high-temperature air from the recuperation zone. Installing an arched brick wall or some hanging stainless steel dampers at the point in the cooler where these two air streams split off in different directions, and adjusting the slope on the cooler roof (approximately 15 degrees as it approaches the cooler throat and 5 to 10 degrees as it approaches the vent air takeoff).<sup>43</sup>

#### ENERGY PERFORMANCE

Savings of 0.05 to 0.08 gigajoules (GJ) per ton of clinker are reported through the improved operation of the grate cooler, and savings of 0.16 GJ per ton of clinker are reported for retrofitting a grate cooler. In another case, thermal energy savings of 0.08 GJ per ton of clinker were coupled by an increase in electricity use of 2.0 kWh per ton of clinker.<sup>44</sup>

Installation of a static grate section could improve the heat recovery rates by 2 to 5 percent.<sup>45</sup>

#### CAPITAL AND OPERATIONAL COSTS

The costs of cooler optimization measures are assumed to be half the costs of replacing the planetary cooler with a grate cooler, or \$0.22 per annual ton of clinker capacity.

Investments for the installation of a static grate are estimated at between \$0.11 and \$0.33 per annual ton of clinker capacity.<sup>46</sup>

---

43 Steuch, “Clinker Coolers.”

44 E. Worell, C. Galitsky, and L. Price, *Energy Efficiency Improvement Opportunities for the Cement Industry* (Berkeley, CA: Lawrence Berkeley National Laboratory, 2008).

45 Ibid.

46 Ibid.

#### RELEVANT FACTORS FOR IMPLEMENTATION

Primary factors influencing the effectiveness of this measure include the existing cooler efficiency, the production rate, the fuel mix, tertiary air requirements for the precalciner, the amount of air leakage, and the desired clinker outlet temperature.

#### COST EFFECTIVENESS PRIORITY

Medium. More effective on high-capacity kilns. Need to balance waste heat needs between drying and heat recovery.

### 2.4.2 VARIABLE SPEED DRIVES FOR COOLER FANS

#### TECHNOLOGY/MEASURE DESCRIPTION

In most plants, the cooler requires a continuously changing air flow in order to provide proper cooling of the clinker. The amount of cooling air provided needs to be adjusted depending on the demand. The use of dampers is a common way of controlling air flow from the fan to the cooler. Although dampers may offer advantages in certain circumstances, generally they are an inefficient flow control approach as the fan continues to operate at full load while substantial energy loss takes place at the damper.

Variable speed drives allow partial load operation of the fan, reducing power consumption and providing more precise control of the cooling air flow. (Figure 10 shows the power consumption of fan installations with different control mechanisms.) When the air pressure at the kiln outlet is to be kept within tight tolerances, without compromising efficient cooling, the exhaust air fan and the clinker cooler fans need to be operated in close cooperation. The use of variable speed drives to control the speed of both clinker cooler fans and exhaust air fans guarantees fast and precise regulation of cooling air and an easy connection to the cement plant's automation system. Variable speed drives also enable soft start of the fans, which minimizes mechanical stress on the fans, pipes, and other mechanical equipment. Through soft start, the supply network can be dimensioned with a low starting current, thus reducing the low-voltage switchgear, transformer, and cabling costs.<sup>47</sup>

---

47 ABB, “AC Drives Ensure Efficient and Precise Cooling of Clinker and Reduce Energy Consumption” (Zurich: 2009).

**Figure 10: Power Consumption of Fan Installations with Different Control Methods**

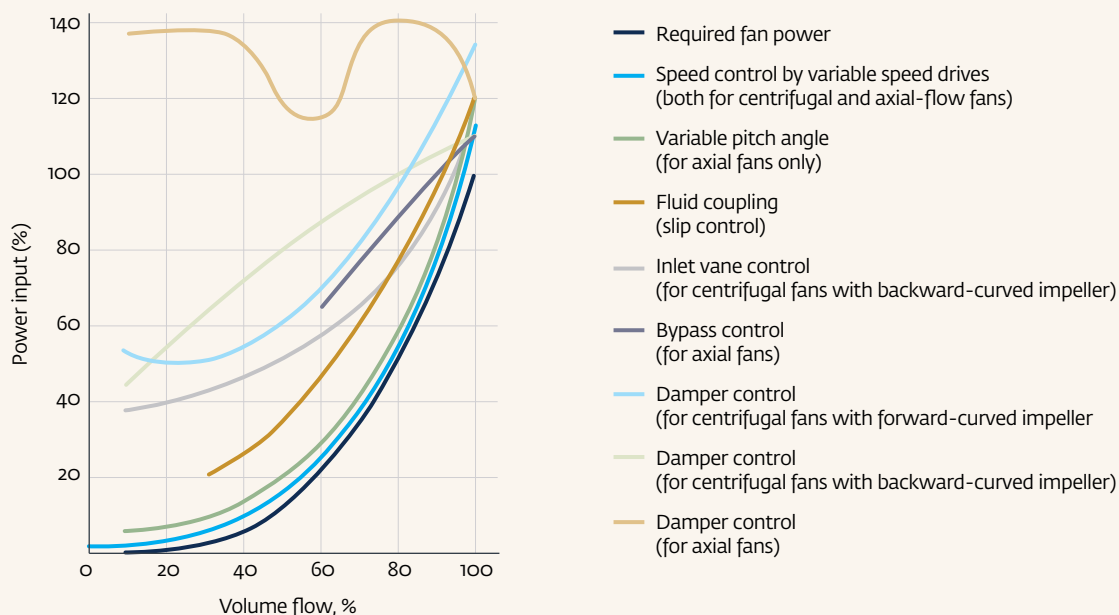

Source: ABB.

Benefits of using variable speed drives in cooler fans include the following:

- Substantial energy savings can be realized through optimal control of cooling air.
- Enables removal of mechanical control devices, for example damper control (plates) of fans, which require regular maintenance due to the harsh environment.
- Enables soft start of fan motors.
- Flying start of fan motors without high-starting torques or high-starting current peaks is possible.
- Easy connection to the cement plant's automation system via various fieldbus adapters.

#### ENERGY PERFORMANCE

Electricity consumption can be reduced by 0.04 to 0.17 kWh per ton of clinker.<sup>48</sup>

#### CAPITAL AND OPERATIONAL COSTS

Capital costs are estimated to be in the range of \$0.01 per annual ton of clinker.

#### COST EFFECTIVENESS PRIORITY

High; however, applicability may be limited depending on the efficiency of current fan and vent systems. Economics also depends on the power price.

### 2.5 FINISH GRINDING

#### 2.5.1 PROCESS CONTROL AND MANAGEMENT IN FINISH GRINDING

##### TECHNOLOGY/MEASURE DESCRIPTION

Grinding operations are highly energy-intensive processes and are coupled with high risk to influence product quality. Process control and management systems aim to maximize production with minimum energy use, while minimizing quality variations. Control systems for grinding operations are developed using the same approaches as for kilns (see above). The systems control the flow in the mill and classifiers, producing a stable and high-quality product. Several systems are marketed by a number of manufacturers. Expert systems have been commercially available since the early 1990s.

In finish grinding, a conventional control solution with proportional–integral–derivative (PID) loops is insufficient, as process delays (for example, fineness analysis delay)

<sup>48</sup> Worell, Galitsky, and Price, *Energy Efficiency Improvement Opportunities for the Cement Industry*.



cannot be handled well. Furthermore, the process contains internal couplings. For example, the separator speed impacts not only the fineness, but also the mill filling level through the reject flow. Therefore, a change in one of the PID loops causes disturbance in the other PID loop, causing a conflict between the loops to reach their own objectives. This lack of coordinated action causes undesired disturbances and operation inefficiency. Expert systems aim to achieve the best possible grinding efficiency through advanced multi-input multi-output control strategies and using model-based predictive control (MPC) techniques. The MPC controller frequently calculates new set points for separator speed and fresh feed rate in order to obtain minimum deviation from production targets and minimum changes of separator speed and fresh feed. The typical parameters monitored and controlled in such systems are summarized in Table 5.

Figure 11 depicts the monitoring and manipulation points of a process control system.

**Table 5: Monitor and Control Parameters**

Parameters Monitored	Parameters Controlled
<ul style="list-style-type: none"> <li>Product quality such as Blaine or online particle size analyzer, SO<sub>3</sub>, LOI; separator and fan speed</li> </ul>	<ul style="list-style-type: none"> <li>Feed and fineness control by fresh feed and separator speed</li> </ul>
<ul style="list-style-type: none"> <li>Fresh and reject feed</li> </ul>	<ul style="list-style-type: none"> <li>Feeder ratio control for quality</li> </ul>
<ul style="list-style-type: none"> <li>Mill folaphone or elevator power</li> </ul>	<ul style="list-style-type: none"> <li>Mill draft</li> </ul>
<ul style="list-style-type: none"> <li>Draft and temperature</li> </ul>	<ul style="list-style-type: none"> <li>Water flow</li> </ul>
<ul style="list-style-type: none"> <li>Feeder response to a given setpoint</li> </ul>	<ul style="list-style-type: none"> <li>Online process state estimation</li> </ul>

According to one manufacturer, while also reducing energy consumption, application of their control system to ball mills typically increases productivity by 6 percent, reduces quality variations by as much as 30 percent, and reduces product change over time between recipes.

**Figure 11: Measurement and Manipulation Points in a Process Control System**

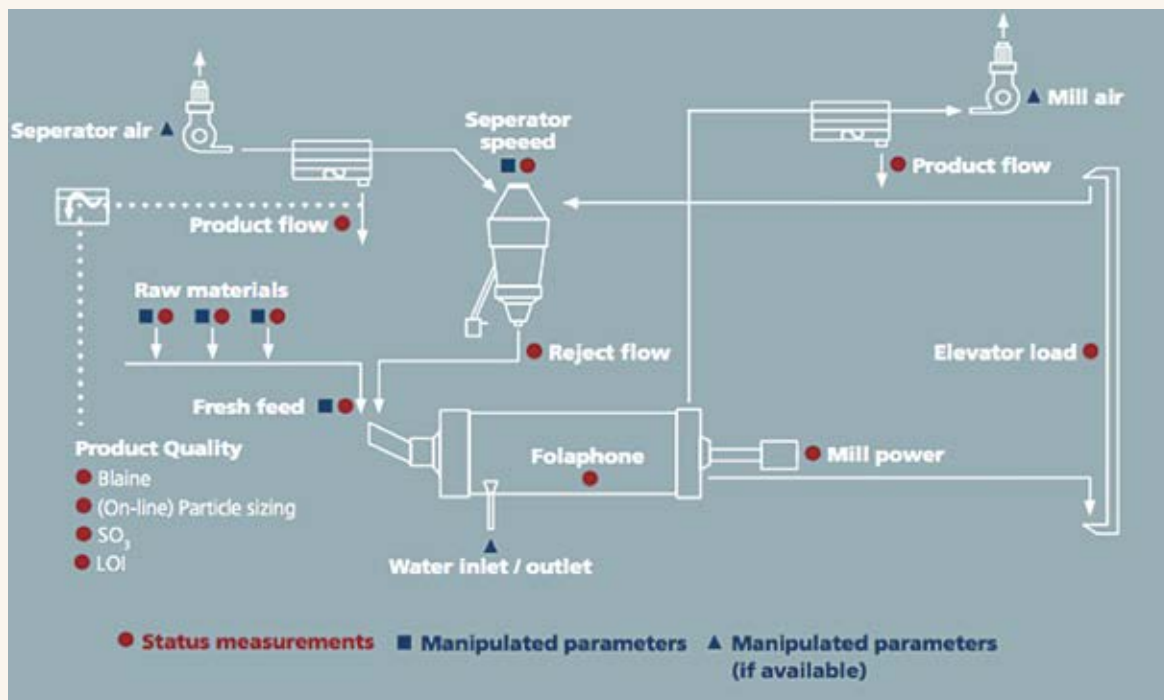

Source: FLSmidth.

## ENERGY PERFORMANCE

Energy savings can be between 2.5 and 10 percent, or between 3.8 and 4.2 kWh per ton of cement.<sup>49</sup>

## CAPITAL AND OPERATIONAL COSTS

The payback is estimated to be between one and two years.

## COST EFFECTIVENESS PRIORITY

High. There are no barriers to installing advanced process controls on new construction. Most existing facilities should be able to retrofit the operations to accommodate control systems.

## CASE STUDY

Maihar Cement in India had earlier adopted an expert control system in its roller press and ball mill combination. In 2008, the plant decided to implement an expert system in two additional mills, following an upgrade of its control system in those mills.

Auto tuning of targets in an automation expert system during mill operation has been very successful, reducing the need to change operating conditions in the mill. The system uses a standard strategy of optimized feed rate and classifier control to regulate the mill loading and separator circuit loading optimization to operate the two mills. These standard controls are assisted by 1) external static pressure fan control to ensure optimum ventilation in the mill and 2) separator fan control to secure an optimum air-to-material ratio in the separator circuit for better separation efficiency. The system continuously sets best mill operation conditions by tracking the achievement of or deviation from targets and making necessary adjustments. These controls, in combination with self-tuning targets, have improved levels of production and quality and reduced specific power consumption in both mills. Table 6 depicts the obtained results.

<sup>49</sup> Ibid.

Mill Number	Production Increase (percent)	Reduction in Specific Power Consumption (percent)
1	9	10
2	17	15

Another important feature is the smooth handling of recipe changeover. This strategy ensures changeover from one product type to another in the shortest possible time with the least loss of production. This is achieved through auto changeover of all operating parameters and manipulated variables.<sup>50</sup>

## 2.5.2 REPLACING A BALL MILL WITH A VERTICAL ROLLER MILL, HIGH-PRESSURE GRINDING ROLLS, OR HOROMILL® FOR FINISH GRINDING

### TECHNOLOGY/MEASURE DESCRIPTION

Cement grinding accounts for nearly 40 percent of the electricity used for cement production. Ball mills commonly used for finish grinding have high energy demands, consuming up to 30 to 42 kWh per ton of clinker depending on the fineness of the cement. Complete replacement of ball mills by more-efficient milling systems, such as vertical roller mills, high-pressure grinding rolls, and Horomills® is regarded as best practice and can improve both energy efficiency and productivity.

Vertical roller mills employ a mix of compression and shearing, using two to four grinding rollers carried on hinged arms riding on a horizontal grinding table. The use of vertical roller mills with an integral separator in finish grinding combines grinding with high-efficiency classification and improves both energy efficiency and productivity.

In high-pressure roller press grinding, the feed material is exposed to very high pressure (up to 3,500 bar) for a short time, improving the grinding efficiency dramatically. High-pressure roller presses are most often used to expand the capacity of existing grinding mills, and are found especially in countries with high electricity costs or with poor power supply. A schematic depiction of a grinding system based on a high-pressure roller press is given in Figure 12.

Whereas required grain sizes up to 4,500 to 5,500 Blaine in vertical roller mills and high-pressure grinding rolls can be achieved, the resulting particle size distribution of the cement (and thus the cement performance) can vary in the different systems, raising the need for product quality-control plans.

<sup>50</sup> FLSmith, "Case Study 1: ECS/ProcessExpert® System Increases Ball Mill Production," [http://www.flsmidth.com/~media/01201KrebsSandStackingCyclones/website/Files/PDF/CaseStudy\\_ECSPXP\\_increases\\_Ball\\_Mill\\_Production.ashx](http://www.flsmidth.com/~media/01201KrebsSandStackingCyclones/website/Files/PDF/CaseStudy_ECSPXP_increases_Ball_Mill_Production.ashx) (2009).

**Figure 12: High-Pressure Roller Press for Finish Grinding**

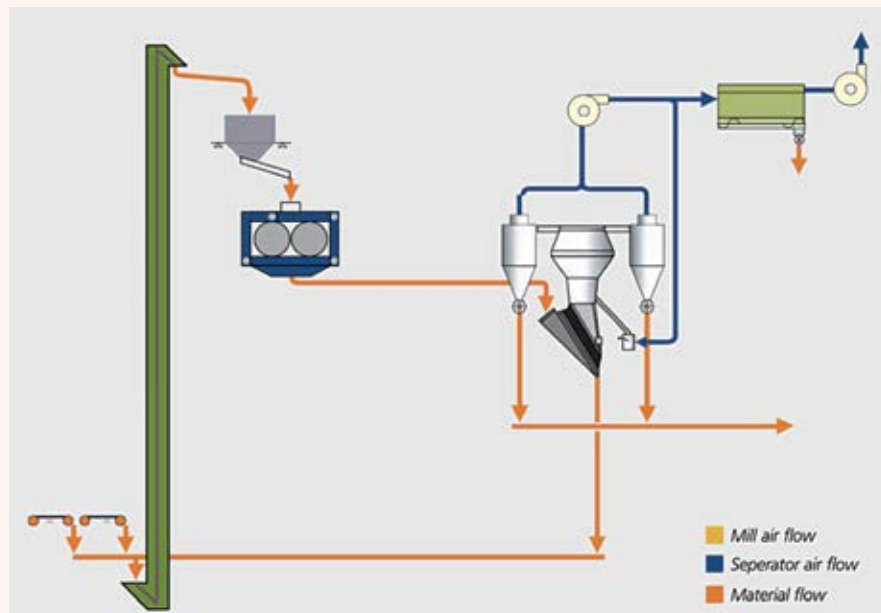

Source: FLSmidth, 2010.

The higher the pressure during comminution, the narrower the particle size distribution and the higher the impact on water demand, strength development, and setting time of the cement paste.<sup>51</sup>

The Horomill® operates on the principle of a horizontal ring-roller mill and was first demonstrated in Italy in 1993. In the Horomill®, a horizontal roller within a cylinder is driven. Like the vertical roller mill, the Horomill® uses the principle of centrifugal force to transport the material (Figure 13). The short mill cylinder driven through a girth gear runs above the critical rotational speed, and a horizontally supported and hydro-pneumatically loaded grinding roller is dragged over the lower cylindrical internal surface of the mill cylinder by frictional engagement with the mill feed. The mill feed introduced at the static end wall of the mill is carried by centrifugal force to the internal cylindrical wall and guided by scrapers into the sickle-shaped stressing gap between the mill cylinder and the grinding roller. The centrifugal forces resulting from the movement of the cylinder cause a uniformly distributed layer to be carried on the inside of the cylinder. The layer passes the roller (with a pressure of 700 to 1,000 bar). The finished product is collected in a dust filter.

<sup>51</sup> ECRA/CSI, *Development of State of the Art-Techniques in Cement Manufacturing*.

Within a grinding plant system, the Horomill® is, without exception, used as a closed-circuit bucket elevator mill. It therefore has relatively low capital costs. For drying raw materials and granulated blast furnace slag with moisture contents of up to 10 percent, it is connected with a flash dryer and, for higher moisture contents, with an “aerodecantor.” The mill can achieve levels of fineness corresponding to Blaine values of up to 5,000 square centimeters per gram when grinding cement. As far as power consumption is concerned, the Horomill® lies between the high-pressure roller press and the vertical roller mill, and, in contrast to the high-pressure roller press in closed-circuit with a high performance separator, it always supplies a finished ground product (Figure 14). In certain installations, parallel arrangement of two mills was implemented, with savings and pooling of resources in the peripheral equipment in order to achieve particularly high outputs and high flexibility. The Horomill® also requires a moderate amount of maintenance and has favorable wear characteristics.<sup>52</sup>

<sup>52</sup> E. Edet, “20 Years of the Horomill – A Review,” *Cement International* 4 (2013): 76–81.

**Figure 13:** Horomill® Concept

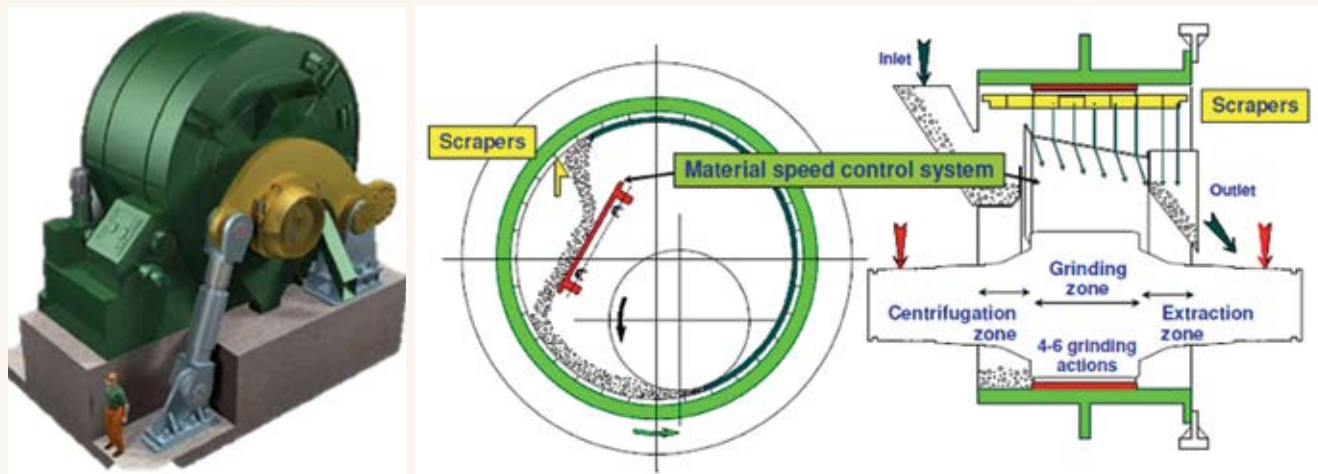

Source: <http://ietd.iipnetwork.org/content/cement-grinding-horomill>.

**Figure 14:** Basic Layout of Cement Grinding Using Horomill®

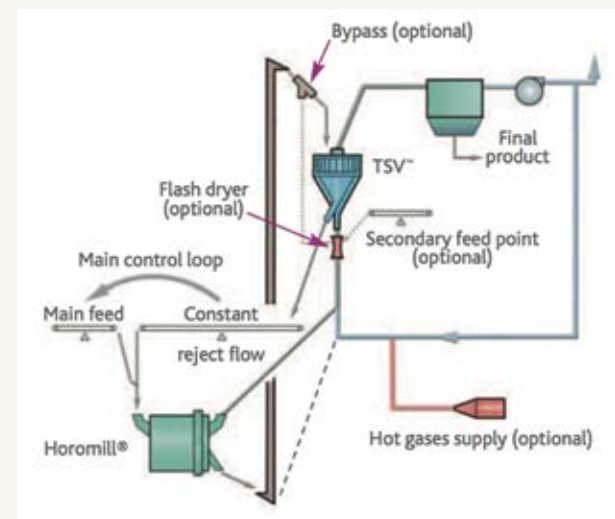

Source: Fives Fcb.

#### ENERGY PERFORMANCE

The energy efficiency of ball mills for use in finish grinding is relatively low, consuming up to 30 to 42 kWh per ton of clinker depending on the fineness of the cement. Power consumption in the finish mill can be reduced to 20 to 30 kWh per ton of clinker with the use of roller presses or roller mills.<sup>53</sup> Energy-savings potential is influenced by the quality requirements of the final product and the specific system layout as well as the auxiliary equipment installed.

Figure 15 shows the extent of energy-saving potential that vertical roller mills offer over ball mills for different product qualities. Typical energy saving by replacing a ball mill with a vertical roller mill is reported to be 9 kWh per ton of cement.<sup>54</sup>

<sup>53</sup> Worell, Galitsky, and Price, *Energy Efficiency Improvement Opportunities for the Cement Industry*.

<sup>54</sup> U.S. EPA, *Available and Emerging Technologies for Reducing Greenhouse Gas Emissions from the Portland Cement Industry*.

**Figure 15: Energy Savings Potential of Vertical Roller Mills versus Ball Mills**

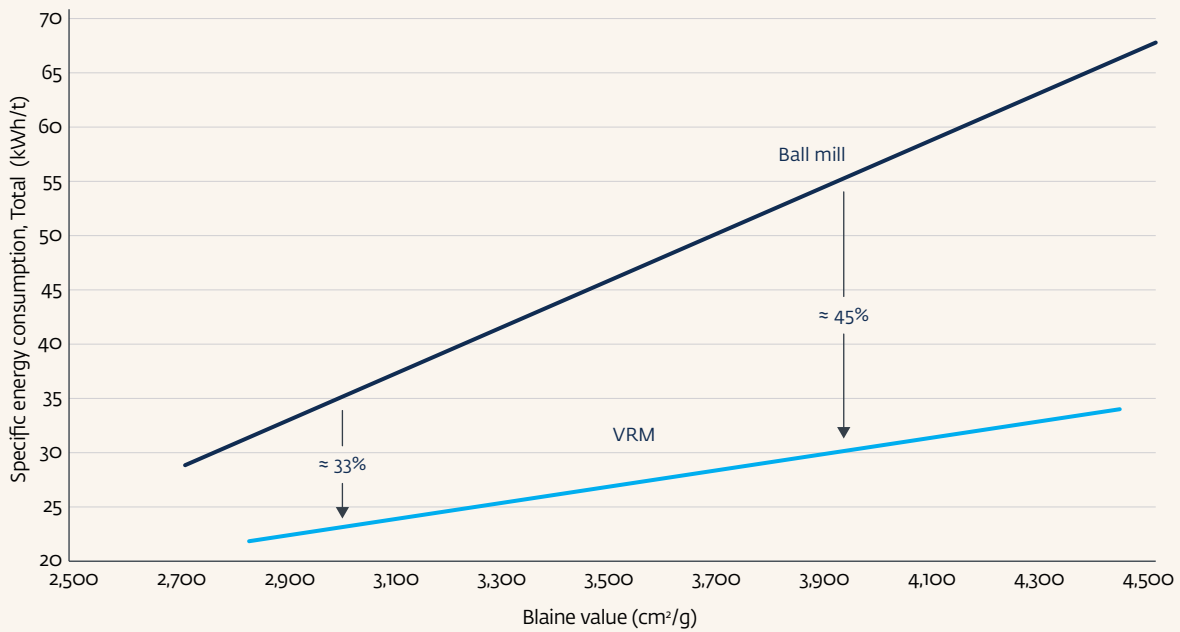

Source: FLSmidth (as appeared in Harder, 2010).

Grinding Portland cement with a Blaine of 3,200 square centimeters per gram in a Horomill® consumes approximately 23 kWh per ton, and even for pozzolanic cement with a Blaine of 4,000, power use may be as low as 30 kWh per ton.<sup>55</sup> Industrial results of the Horomill® operating worldwide have shown energy savings ranging between 35 and 70 percent, as shown in Figure 16.

#### CAPITAL AND OPERATION COSTS

Replacing ball mills with vertical roller mills is estimated to require an investment cost of \$35 per ton of cement capacity and to increase operating costs by \$0.17 per ton of cement to account for more-frequent maintenance. Power savings were estimated to be 9 kWh per ton of cement.

**Figure 16: Energy Savings Potential of Horomill®**

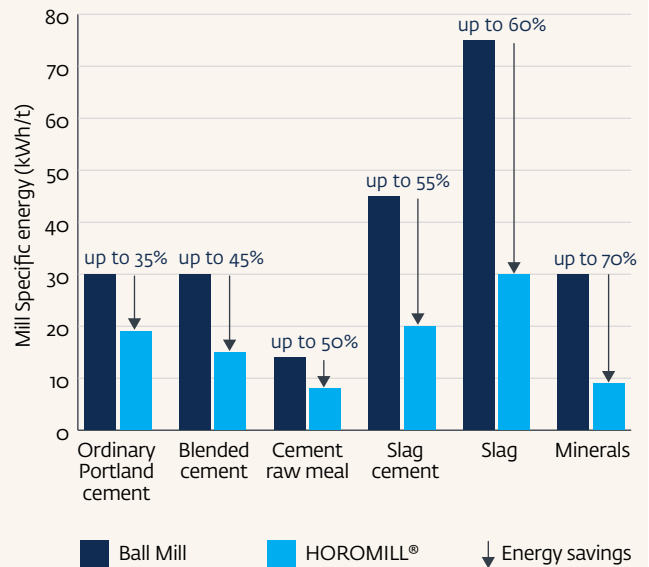

Source: Fives Fcb.

<sup>55</sup> Worell, Galitsky, and Price, *Energy Efficiency Improvement Opportunities for the Cement Industry*.

Capital cost estimates for installing a new roller press vary widely in the literature, ranging from low estimates of \$2.5 to \$3.6 per annual ton of cement capacity to high estimates of \$8 per annual ton of cement capacity.<sup>56</sup>

Additionally, new grinding technologies may reduce operating costs by as much as 30 to 40 percent.

#### RELEVANT FACTORS FOR IMPLEMENTATION

Vertical roller mills had initial issues with vibration in the mill, wear of the grinding roller and grinding disc, and product quality issues in finish grinding. These issues generally have been with more recent systems. This technology is considered to be suitable for new installations as well as for those undertaking major upgrades. Plants interested in this technology are advised to carefully consider logistical aspects of maintenance and parts replacement by technology providers.<sup>57</sup>

In pure energy efficiency terms, when using vertical roller mills in finish grinding, the benefit of grinding power reduction is countered by the very high power required by mill fans. In addition, the absence of the heat generated in a ball mill and the high volume of air required by the vertical mill have required the provision of waste heat from cooler exhausts and/or auxiliary furnaces to dry raw materials and achieve a limited dehydration of gypsum.<sup>58</sup>

#### COST EFFECTIVENESS PRIORITY

Medium. Effectiveness depends on clinker properties, desired product quality, and equipment durability. Initial problems with equipment reliability, maintenance, and product quality have been solved in current product offerings.

## 2.5.3 OPTIMIZING THE OPERATION OF A CEMENT MILL

### TECHNOLOGY/MEASURE DESCRIPTION

Ball mills account for the majority of all mills in cement plants, and therefore the optimization of established ball mills has high savings potential. Fine tuning of operating parameters represents an attractive approach because almost no additional capital costs are required. Parameters that hold potential for energy savings are load level, revolution speed, combination of the ball charge, lining design, and the adjustments of the separator. Standard optimization methods include meter sampling of the effective length as well as separator sampling. By determination of the particle size distribution, electricity reduction potentials can be revealed. In addition, enhanced measures have been developed that allow for more directed control of the grinding process. This includes electric ears with a downstream frequency analysis for a wide range of oscillations or online monitoring. Feeding such monitoring data to expert control or fuzzy logic systems can support mill optimization. As mentioned earlier, the main obstacles are the complex interdependences between the mentioned parameters. The modeling and simulation of ball mills have proven to be effective methods for obtaining further understanding. Besides providing savings in electricity, this can reduce the cost induced by wear.<sup>59</sup>

Optimizing the grinding media in the ball mill is another measure that can reduce energy consumption and increase productivity.

### ENERGY PERFORMANCE

Electricity consumption can be decreased by between 0 and 2 kWh per ton of cement.

### CAPITAL AND OPERATIONAL COSTS

For a 2 million ton per year plant, the installation costs are estimated to be around €0.01 million. Operational costs are expected to decrease by €0 to €0.15 per ton of cement.

---

<sup>56</sup> Ibid.

<sup>57</sup> Ministry of Industry and Information Technology, *Advanced and Applicable Technology Guide for Energy Saving and Emission Reduction in Building Materials Industry* (First Batch) (September 2012), 26–27.

<sup>58</sup> L. Evans, “Best Energy Consumption,” CemNet.com (February 16, 2015).

---

<sup>59</sup> ECRA/CSI, *Development of State of the Art-Techniques in Cement Manufacturing*.

## RELEVANT FACTORS FOR IMPLEMENTATION

The effect of the measure is highly dependent on the clinker properties (grindability, moisture content) as well as product qualities (for example, fineness).

The measure requires a deeper understanding of the grinding process. For bigger improvements, better control and measurement techniques and improved modeling and simulation approaches are needed.

## COST EFFECTIVENESS PRIORITY

Medium. Requires deep understanding of the grinding process and better measurement and control techniques. Methods for modeling and simulation of the comminution process are still improving.

### 2.5.4 HIGH-PRESSURE ROLLER PRESS AS A PRE-GRINDING STEP FOR BALL MILLS

#### TECHNOLOGY/MEASURE DESCRIPTION

Product quality concerns related to complete replacement of ball mills with alternative milling systems can be addressed by combined grinding layouts. These systems are commonly installed, set the standard for product quality, and do not have to face quality problems. One such system involves the use of a high-pressure roller press as a pre-grinding step for ball mills.

In high-pressure roller press comminution, the feed material is exposed to very high pressure for a short time. The high pressure causes the formation of microcracks in the feed particles and generates a substantial amount of fine material. If the pressed material is fed directly to a ball mill, the power consumption required to produce finished cement will be much lower than that of a mill fed with unpressed material. This makes it possible to increase the throughput of a given size ball mill and to reduce the specific power consumption of the whole mill system.

Here, two process configurations are possible. In the pre-grinding system, the roller press is used for grinding fresh feed and a certain amount of recirculated pressed flakes. The roller-pressed material is finish-ground in a conventional ball mill grinding circuit. Excessive flake recirculation may cause operational instability, so, in practice, the power consumption of the roller press is limited

to approximately 5 kWh per ton in the pre-grinding mode. Such a configuration is demonstrated in Figure 17.

A better use of the high-pressure roller press can be ensured when it is used as a semi-finish grinding system. The roller press operates in closed circuit with two separators on top of each other: a static separator that undertakes both disagglomerating and coarse separation, and a dynamic separator. Fines from the roller press circuit are finish-ground in a one-compartment ball mill to the required fineness.

A very compact and energy-efficient semi-finish grinding installation can be attained by combining the roller press and the ball mill with a two-stage separator. The roller press then operates in closed circuit with the static separator working as both disagglomerator and coarse separator, while the ball mill operates in closed circuit with the high-efficiency dynamic separator. Because the separator air is used for both separation stages, the overall quantity of air and the fan power consumption remain at a very low level. Such a configuration is depicted in Figure 18.

**Figure 17:** High-Pressure Roller Press as a Pre-grinding Step for Ball Mills

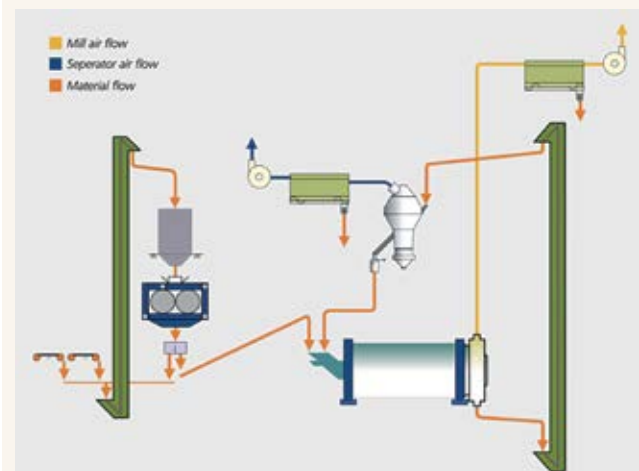

Source: FLSmidth, 2010.

**Figure 18:** High-Pressure Roller Press as a Semi-finish Pre-grinder with Two-stage Separator

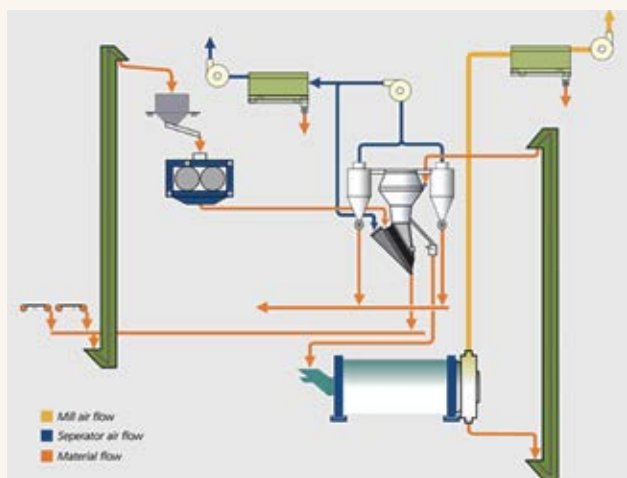

Source: FLSmidth, 2010.

Such pre-grinding configurations can greatly increase throughput (up to 100 percent increases are reported in India) as compared to single-stage grinding in ball mills. They are particularly interesting for countries with high electricity costs or with poor power supply. Multi-stage configurations are, however, more complex to operate.

### ENERGY PERFORMANCE

Saving potentials approach 30 percent.

Reductions in specific energy consumption have been reported in the range of 7 to 24 kWh per ton of cement.<sup>60</sup>

In China, reductions in specific electricity consumption of 8 to 12 kWh were achieved, representing 15 to 30 percent savings over a traditional ball mill system. For a typical 5,000 ton per day plant in China, such configurations are reported to save 20 terawatt-hours per year.<sup>61</sup>

<sup>60</sup> Worell, Galitsky, and Price, *Energy Efficiency Improvement Opportunities for the Cement Industry*.

<sup>61</sup> Chinese Ministry of Industry and Information Technology, *Advanced and Applicable Technology Guide for Energy Saving and Emission Reduction in Building Materials Industry* (first batch) (Beijing: 2012).

### CAPITAL AND OPERATIONAL COSTS

For a 100 ton per hour mill in Japan, the installation costs are reported to be about \$2.7 million (\$1 = 110 Japanese yen), including auxiliary and construction.

For India, installation costs are reported to be between \$10 million and \$20 million, or between \$55,000 and \$65,000 per ton per hour of system capacity.

### COST EFFECTIVENESS PRIORITY

Medium to low, depending on total capital cost and the potential extent of productivity gains. Effectiveness depends on clinker properties, desired product quality, and equipment durability.

### CASE STUDIES

Hefei Donghua Building Materials Co., Ltd. in China installed a combined open-circuit roller press (HFCG160-140), SF650/140 dispersing classifier and a  $\phi 4.2 \times 13.0$ m ball mill and reached a capacity of 180 tons per hour, with specific grinding power consumption of 27 kWh per ton of cement and overall grinding station consumption of less than 32 kWh per ton of cement—saving 12 kWh per ton of cement as compared to a traditional ball mill system. The company realized annual savings of more than 6 million Chinese renminbi, due to reduced electricity consumption.

In another Chinese case, Tianjin Zhenxing Cement Co, Ltd. reduced specific energy consumption by 7.0 kWh per ton of cement by installing a combined roller press and ball mill grinding system in a 2,400 ton per day cement production line. For an annual production of 900,000 tons, this provides a saving of around 6.3 terawatt-hours per year. The plant realized annual savings of more than 3 million Chinese renminbi due to reduced power consumption.<sup>62</sup>

## 2.5.5 IMPROVED GRINDING MEDIA FOR BALL MILLS

### TECHNOLOGY/MEASURE DESCRIPTION

Improved wear-resistant materials can be installed for grinding media, especially in ball mills. Grinding media are usually selected according to the wear characteristics of the material. Increases in the ball charge distribution and surface hardness of grinding media and wear-resistant mill linings

<sup>62</sup> Ibid.



have shown a potential for reducing wear as well as energy consumption. Improved balls and liners made of high-chromium steel are one such material, but other materials also are possible. Other improvements include the use of improved liner designs, such as grooved classifying liners.

#### ENERGY PERFORMANCE

Power use can be reduced by 5 to 10 percent in some mills, which is equivalent to estimated savings of 3 to 5 kWh per ton of cement.<sup>63</sup>

#### CAPITAL AND OPERATIONAL COSTS

Based solely on energy savings, the payback times are estimated to be around eight years.<sup>64</sup>

#### COST EFFECTIVENESS PRIORITY

Low. Potential improvements are relatively limited compared to cost.

### 2.5.6 HIGH-EFFICIENCY CLASSIFIERS

#### TECHNOLOGY/MEASURE DESCRIPTION

Earlier-generation classifiers had low separation efficiencies compared to modern higher-efficiency designs. The lower separation efficiency leads to the recycling of fine particles, resulting in extra power use in the grinding mill. As a result, the number of circulations of the mill feed declines and the throughput rises (by up to 15 percent). This also involves a reduction of the specific energy demand compared to grinding circuits with lower efficiency separators. Newer designs of high-efficiency separators (Figure 19) aim to improve the separation efficiency further and reduce the required volume of air (hence reducing power use).

#### ENERGY PERFORMANCE

Overall grinding energy use can be reduced by 10 to 15 percent, despite the extra power required by higher-efficiency separators.

Energy savings of between 0 and 6 kWh are reported, depending on the existing plant configuration, the type of cement, and the fineness required.

63 Worell, Galitsky, and Price, *Energy Efficiency Improvement Opportunities for the Cement Industry*.

64 Ibid.

**Figure 19:** Schematic of a High-Efficiency Separator/Classifier

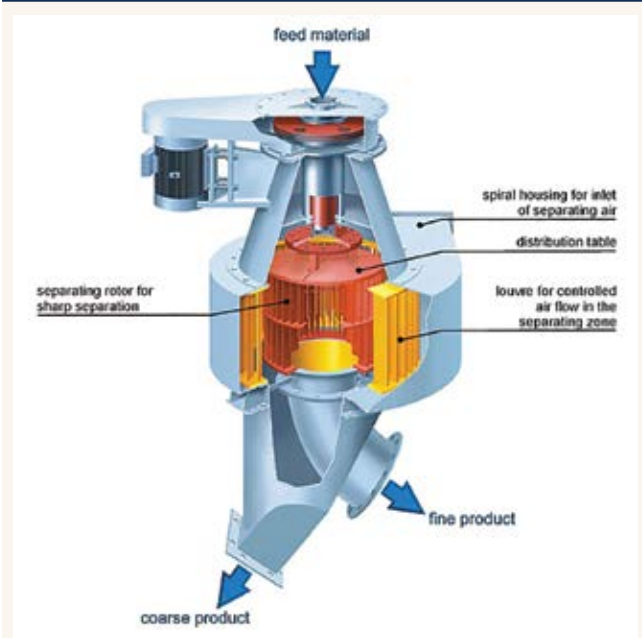

Source: Gebr. Pfeiffer and <http://ietd.iipnetwork.org/content/high-efficiency-separatorsclassifiers-finish-grinding>.

Typical savings of 5 kWh per ton of cement are reported in China.

#### CAPITAL AND OPERATIONAL COSTS

Investment costs were estimated at \$2 per annual ton of finished material. Operational costs were estimated to increase by \$0.04 per ton of cement.

Capital costs for both new installations and retrofitting in Europe are estimated at €2.5 million (for a plant size of 2 million tons per year of capacity). The operational costs are expected to go down by €0.28 per ton of cement.

For India, the investment costs are reported to vary between \$0.2 million and \$0.4 million, or around \$20,000 per ton of hourly capacity.

#### RELEVANT FACTORS FOR IMPLEMENTATION

This conversion would require, in addition to the high-efficiency classifier, a product dust collector and a new fan. Retrofitting existing facilities with high-efficiency classifiers should be considered where the physical layout of the finish grinding system allows it.

The separator technology has to be optimized for each application.

The particle size distribution of the finished material will be slightly changed (lower proportion of fines), but not to the extent that the quality of the cement is significantly affected.

To ensure process reliability and to use the separators to full capacity, the operation parameters of the particular mill have to be adjusted, which is very often restricted by the still-limited knowledge of the comminution mechanisms.

The impact of grinding aid has to be specified for each product (for example, workability).

#### *COST EFFECTIVENESS PRIORITY*

Medium to high. Effectiveness depends on clinker properties, product quality and condition, and the efficiency of existing classifiers, but demonstrated payback periods for the investment have been low. Applicability also is limited by physical layout limitations.

#### *CASE STUDIES*

In Hushan Group's 5,000 ton per day plant in Zhejiang, China, the installation of a high-efficiency separator/classifier took three months to complete. The unit reduced specific energy consumption in finish grinding from 36 kWh to less than 31 kWh per ton of cement. Annual electricity savings of 10 gigawatt hours are realized, corresponding to annual production of 2 million tons of cement. The installation required an investment of 2 million Chinese renminbi and was paid back in less than one year.

Huaihai China United Cement Company Limited also installed a high-efficiency separator/classifier in its 3,700 ton per day plant and thereby reduced specific energy consumption in finish grinding by 2 to 3 kWh per ton of cement, resulting in annual electricity savings of around 4.2 gigawatt hours. The unit required an investment of 2.4 million Chinese renminbi and took one month to complete. The system helped improve the product quality, increased output by 10 percent, allowed for increased use of cement additives by 5 to 10 percent, and reduced dust emissions. The payback time for the investment was less than one year.

## 2.5.7 HIGH-EFFICIENCY FANS FOR CEMENT MILL VENTS

### *TECHNOLOGY/MEASURE DESCRIPTION*

As discussed earlier, process fans in a cement plant are the second-largest users of electricity; therefore, measures that can reduce their power consumption are important. With better construction materials for fans and with design optimization, fans with a higher operating efficiency are available for all cement industry applications. These modern fans are designed for higher energy efficiency, higher wear resistance, lower material buildup and effects of erosion, better speed control, low vibrations, and high operational stability. Fans with higher energy efficiency (82 to 84 percent efficiency) can replace inefficient fans in finish grinding by both design and by retrofit. Higher pressure drops in inlet duct systems also can be analyzed and reduced by using computational fluid dynamics techniques.

### *ENERGY PERFORMANCE*

In an Indian plant, replacement of the cement mill fans with more-efficient versions reduced the energy consumption by 0.13 kWh per ton of cement.

### *CAPITAL AND OPERATIONAL COSTS*

For India, the implementation costs of this measure are reported to be between \$0.05 million and \$0.15 million depending upon the capacity, or around \$400 per ton of hourly mill capacity.

### *COST EFFECTIVENESS PRIORITY*

High; however, applicability may be limited depending on the efficiency of current fan and vent systems. Economics also depends on the power price.

### *CASE STUDIES*

Siam White Cement Co., Ltd., located in Saraburi, Thailand, is the largest white cement producer in the country with a production capacity of 160,000 tons. The company's team found that electricity consumption at Cement Mill 1 was excessive due to the high separator load (kilograms of cement per cubic meter of air). The airflow rate could be increased by installing a new efficient circulating fan that would reduce the separator load and electricity consumption.

Three new efficient circulating fans (35 kW, 35 kW, and 70 kW) were selected to replace the existing circulating fans at Cement Mill 1.

The implementation requires a \$30,000 investment, and expected annual savings are \$25,000, with a 1.2-year payback period. Expected electricity savings are 427,300 kWh (almost 10 percent) per year, which is equivalent to the reduction of 264 tons of carbon dioxide emissions per year. The installation of efficient circulating fans also could increase the cement production rate by more than 14 percent.<sup>65</sup>

## 2.6 GENERAL MEASURES

In addition to the specific measures above, a number of general measures to improve energy efficiency and reduce associated emissions can be considered by cement plants.

### 2.6.1 HIGH-EFFICIENCY MOTORS AND EFFICIENT DRIVES

Motors and drives are used throughout a cement plant to move fans (for example, preheater, cooler), to rotate the kiln, to transport materials, and, most importantly, for grinding. In a typical single kiln cement plant, 500 to 700 electric motors may be used, varying from a few kW to MW size. Cement producers can achieve significant energy savings by

using high-efficiency motors and drives. Figure 16 shows the typical efficiencies of electrical motor classes according to IEC60034-30: 2008 definition. Although rewiring old motors is a more common practice in industry, replacing the old motors with new and more efficient ones may prove more beneficial, particularly in light of the fact that a motor can cost 100 times more to run over its lifetime than its cost of purchase.

For example, for rotating the kiln—a task that requires significant amounts of power—direct current (DC) motors are traditionally used. Recently, replacement of these DC motors with alternating current (AC) versions is increasingly advocated. Thanks to technological advances, modern AC drives are able to supply the enormous starting torque required for cement kilns. These drives also use less energy, are more reliable, and are easier to maintain. Similarly, high-efficiency motors used in other applications not only reduce energy consumption, but also are typically more reliable, last longer, and result in lower transformer loading.

Further, it is not uncommon to find that motors used in industry are oversized. This results in poor efficiency, which leads to more energy consumption and a higher energy cost (by more than 25 percent in certain scenarios). Therefore, onsite motor loading surveys and corrective action must be a part of any comprehensive energy conservation effort.

65 Energy Efficiency Asia, *SIAM WHITE CEMENT Co., Ltd: Energy Consumption Reduction at Cement Mill*, 2006.

**Figure 20:** Efficiency Ranges for Different Motor Classification

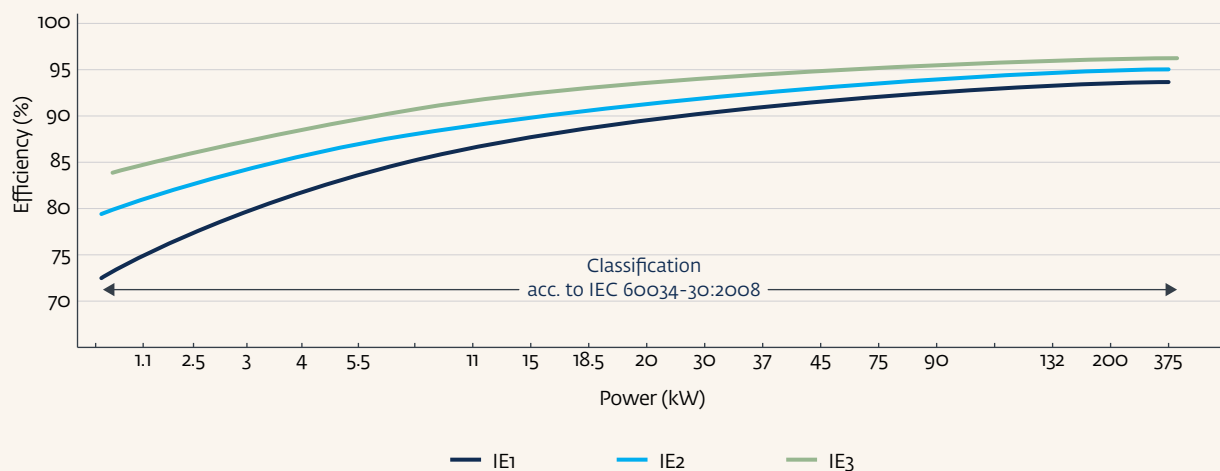

## ENERGY PERFORMANCE

Power savings may vary considerably by plant, ranging from 3 to 8 percent.<sup>66</sup> Substituting the DC motor system with an AC version for the kiln drive may result in a reduction in electricity use of the kiln drive of between 0.5 and 1 percent.<sup>67</sup>

When considering smaller motors used in other applications, high-efficiency motors are typically between 1 and 4 percent more efficient than traditional ones.

## CAPITAL AND OPERATIONAL COSTS

For a 5,000 ton per day plant, it is estimated that replacing all motors in plant fan systems with high-efficiency motors costs \$0.22 per annual ton of cement capacity.<sup>68</sup> AC drives for kiln systems have a lower investment cost than DC drives.

## FACTORS FOR IMPLEMENTATION

If the replacement does not influence the process operation, motors may be replaced at any time. Further, oversized motors are commonly found in cement plants, resulting in poor energy efficiency and high consumption and costs. Therefore, onsite motor loading surveys and corrective action must be a part of any comprehensive energy conservation effort.

## COST EFFECTIVENESS PRIORITY

High; however, applicability may be limited depending on the efficiency of current fan and vent systems. Economics also depends on the power price.

## CASE STUDY

By retrofitting 13 motors with high-efficiency versions, a cement plant in Davenport, California, has saved 2.1 megawatt hours of electricity annually. The plant has reduced its annual energy and maintenance costs by \$168,000 and \$30,000, respectively. The implementation costs amounted to

\$134,000 (including a rebate from the local utility company), giving a payback time of around eight months.<sup>69</sup>

## 2.6.2 VARIABLE SPEED DRIVES

Most electric motors used in cement plants are fixed-speed AC models; however, motor systems are often operated at partial or variable load, particularly in cement plants where large variations in load often occur. Variable speed drives can increase motor efficiency by decreasing throttling and coupling losses. Variable speed drives can be applied primarily for fans in the kiln, clinker cooler, preheater, separator, and mills, and for various drives in a cement plant.

## ENERGY PERFORMANCE

Variable speed drives can reduce electricity consumption by between 7 and 60 percent, depending on the flow pattern and loads in a plant.<sup>70</sup> Other sources estimate the potential savings to be 15 to 44 percent of the installed power, or roughly equivalent to 8 kWh per ton of cement.<sup>71</sup>

## CAPITAL AND OPERATIONAL COSTS

The specific costs depend strongly on the size of the system. In Europe, for systems over 300 kW, the costs are estimated at €70 per kW (\$75 per kW) or less, and for systems in the range of 30 to 300 kW, costs are estimated at €115 to €130 per kW (\$120 to \$140 per kW).<sup>72</sup> Based on these, the specific costs for a modern cement plant were estimated to be roughly \$0.9 to \$1.0 per annual ton of cement capacity. In India, the costs of high-temperature and low-temperature variable speed drives are assumed to be \$240 to \$300 per kW and \$120 to \$200 per kW, respectively.<sup>73</sup>

66 Worell, Galitsky, and Price, *Energy Efficiency Improvement Opportunities for the Cement Industry*.

67 ESKOM, *Concrete Steps Towards Profitability—Solid Ways to Ensure Energy Efficient Cement Production* (Sunninghill, Sandton, South Africa: 2011).

68 Worell, Galitsky, and Price, *Energy Efficiency Improvement Opportunities for the Cement Industry*.

69 U.S. Department of Energy, *CEMEX: Cement Manufacturer Saves 2.1 Million kWh Annually with a Motor Retrofit Project* (Washington, DC: 2005).

70 ECRA/CSI, *Development of State of the Art-Techniques in Cement Manufacturing*.

71 Worell, Galitsky, and Price, *Energy Efficiency Improvement Opportunities for the Cement Industry*.

72 ECRA/CSI, *Development of State of the Art-Techniques in Cement Manufacturing*.

73 CSI, *Existing and Potential Technologies for Carbon Emissions Reductions in Indian Cement Industry*.

### COST EFFECTIVENESS PRIORITY

High; however, applicability may be limited depending on the efficiency of current fan systems. Economics also depends on the power price.

### 2.6.3 PREVENTATIVE MAINTENANCE

While many processes in cement production are primarily automated, there are still opportunities to increase energy savings through preventative maintenance. Preventative maintenance will assure that the equipment and other infrastructure is in good condition to deliver optimal outputs. In addition to energy savings, preventive maintenance can help avoid problems with product quality, reduce downtime, and improve capacity utilization. Maintenance of the kiln refractories, or reduction of false air input into the kiln, are among typical areas where preventive maintenance can focus. Effective preventive maintenance will require the development and implementation of a carefully crafted maintenance plan, as well as basic training of the employees.

### ENERGY PERFORMANCE

Savings that can be harvested through preventive maintenance will depend on the measures already taken in a particular plant. Reduction of up to 5 kWh per ton of clinker through various preventative maintenance and process control measures have been reported. Typical savings are around 3 kWh per ton of clinker.<sup>74</sup>

### CAPITAL AND OPERATIONAL COSTS

Startup and implementation costs of preventive maintenance tend to be very low, often resulting in payback times of less than one year.

### COST EFFECTIVENESS PRIORITY

High. Preventive maintenance is low cost and should be included as standard procedure in plant operation.

### 2.6.4 COMPRESSED AIR SYSTEM OPTIMIZATION AND MAINTENANCE

Compressed air is often called the “fourth utility” in many facilities, after electricity, fuel, and water. For most cement

plants, compressed air is a vital input to the production process. However, too often, compressed air systems are highly inefficient, resulting in significant wasted energy and cost. While compressed air is often considered low cost, it can be fairly expensive given that only 10 to 20 percent of the electric energy input reaches the point of end use. The remaining energy is converted to wasted heat or is lost through leakage. Below are several best practices that can be used to improve air compressor system efficiency and reduce costs:

1. **Detect and Repair Leaks.** Leaks in an industrial compressed air system can waste significant amounts of energy, as much as 20 to 30 percent of compressor output. Detection and repair can reduce leaks to less than 10 percent of compressor volume. Leak repair, when combined with adjustments to compressor controls, can reduce compressor run time, increase equipment life, and reduce maintenance. However, without appropriate compressor controls, there may not be much energy savings. Repairing leaks also reduces demand for new compressor capacity by reducing wasted air. While leakage may come from any part of the system, the most common problem areas are couplings, pressure regulators, condensate traps, shut-off valves, and pipe joints.
2. **Eliminate Inappropriate and Unnecessary Uses.** Compressed air generation is one of the most expensive auxiliary processes for an industrial facility. Over 80 percent of the electricity used for this process is attributed to wasted heat at the compressor. Plants need to consider more cost-effective ways to accomplish the same tasks. If air nozzles are required, a Venturi-type nozzle can significantly reduce compressed air demand, as well as lower noise levels. If an air motor is used for mixing, a plant can consider replacing this with an electric motor. The plant also can check to ensure that air is not being supplied to unused or abandoned equipment.
3. **Minimize Pressure Drop.** Pressure drop is the reduction in air pressure from the compressor to the actual point of use. A properly designed system should have a pressure drop of below 10 percent of the compressor’s discharge pressure. Systems are frequently operated at higher pressures than necessary to compensate for unnecessary pressure drops, which waste energy and money. The most

---

<sup>74</sup> Worell, Galitsky, and Price, *Energy Efficiency Improvement Opportunities for the Cement Industry*.

frequent problem areas are after-coolers, separators, dryers, filters, regulators, and poor connection practices at the point of use. For systems in the range of 100 pounds per square inch gauge (psig), every increase in discharge pressure of 2 pounds per square inch (psi) will increase energy consumption by about 1 percent at full load.

4. **Reduce System Pressure.** Many plant air compressors operate with a full load discharge pressure of 100 psig and an unload discharge pressure of 110 psig or higher. The actual pressure requirements of machinery and tools are often 80 to 90 psig or lower. Reducing and controlling system pressure downstream of the primary receiver can reduce energy consumption, leakage, and demand for new capacity, as well as cause less stress on components and operating equipment. However, caution should be exercised in lowering system pressure because large changes in demand can cause the pressure at points of use to fall below minimum requirements. This can be avoided by carefully matching system components, controls, and storage. Plants can address unnecessary pressure drops prior to lowering system pressure. In some plants, the high-pressure requirements of a few uses drive the pressure requirements for the entire system. If these uses can be supplied by a dedicated compressor, the rest of the system can operate effectively at a lower pressure.
5. **Size and Control Compressors to Match Loads.** Since compressor systems are typically sized to meet a system's maximum anticipated demand, a control system often is required to reduce output for low-demand periods. The compressor package usually includes controls. For systems with multiple compressors, it is usually good practice to follow a baseload/trim strategy. This allows some compressors to be fully loaded to meet the baseload demand. The compressor(s) with the highest part-load efficiency is placed in trim service to handle variations in load. This strategy requires controls that operate the group of compressors as an integrated whole. This is typically far more efficient than placing compressors in modulation, which is a common practice. An effective control strategy includes adequate storage. A plant can employ storage to cover peak air demands by reducing both the amount of pressure drop and the rate of pressure decay by locating receivers near surge demands. For systems with highly variable air demand, the plants can achieve tight control by combining storage with a pressure/flow controller. Narrowing the pressure variation with better controls uses less energy and minimizes potential negative effects on product quality.
6. **Use Efficient Part-Load Controls.** For rotary screw compressors, throttling the air can allow the output of a compressor to meet flow requirements. Throttling is usually accomplished by closing down the inlet valve, which restricts inlet air to the compressor. However, this control scheme is inefficient for controlling compressor output for displacement compressors. Most manufacturers offer control options for larger compressors that are more efficient at part loads. Load/unload controls can improve the efficiency at part-load operation if there is enough storage capacity. Another efficient approach uses variable displacement control or variable capacity control, which reduces the effective length of the rotors at part loads. Variable speed control can be a very efficient approach to provide "trim" duty. Proper selection of part-load controls depends on specific compressed air system requirements.
7. **Optimize Distribution System Operation.** The air distribution system that connects major compressed air system components is very important. Appropriate sizing and layout will ensure proper air supply, good tool performance, and optimal production. A plant can size and arrange the complete drying, filtration, and distribution system so that the total pressure drop from the air compressor to the points of use is below 10 percent of the compressor discharge pressure. The plant can choose equipment and piping components to avoid excessive pressure drops and leakage. A plant also may dramatically improve the operation of existing systems by replacing worn-out or inadequately sized hoses and couplings, inspecting and maintaining filter/regulator/lubricator components, and installing adequate storage.
8. **Improve Routine Maintenance.** Inadequate compressor maintenance can increase energy consumption significantly via lower compression efficiency, air leakage, pressure variability, higher operating temperatures, poor moisture control, and poor air quality. A plant can keep

radiators clean and clear of oil and sawdust to keep the air and oil cool. This can add up to thousands of dollars every year. The plant also can inspect and adjust controls periodically to ensure that they are operating properly and at appropriate settings for system requirements. For basic maintenance, the plant can inspect and clean inlet filters, drain traps, maintain lubricant levels, condition belts, maintain operating temperature, inspect air-line filters, and check water cooling systems.

In addition to the general best practices for air compressor system efficiency listed above, the following three measures are particularly effective when implemented at cement facilities.

#### 2.6.4.1 COMPRESSED AIR SYSTEM MAINTENANCE

Proper maintenance of compressed air systems is of utmost importance and can help maintain compression efficiency, reduce air leakage or pressure variability, and avoid increased operating temperatures, poor moisture control, and excessive contamination. Proper maintenance includes the following:

- Keeping the compressor and intercooling filters clean and foul-free.
- Keeping motors properly lubricated and cleaned.
- Regularly inspecting drain traps.
- Maintaining the cooler to assure lowest possible inlet temperature to the dryer.
- Adjusting the belts and checking them for wear.
- Replacing air lubricant separators at optimal intervals.
- Maintaining the water quality of water cooling systems.

#### ENERGY PERFORMANCE

Through more-frequent filter changing, a 2-percent reduction of annual energy consumption in compressed air systems can be realized.<sup>75</sup>

#### CAPITAL AND OPERATIONAL COSTS

The payback for filter cleaning and maintaining drain traps is usually under two years.

#### COST EFFECTIVENESS PRIORITY

High. Economics also depends on the power price.

#### 2.6.4.2 REDUCING LEAKS IN COMPRESSED AIR SYSTEMS

Leaks in compressed air systems are very common and are significant sources of wasted energy and money. Plants without proper maintenance of the system may have 20 to 50 percent leakage, and this value can be reduced to below 10 percent with proper leak detection and correction programs. Couplings, hoses, tubes, fittings, pressure regulators, open condensate traps and shut-off valves, pipe joints, disconnects, and thread sealant are among the most common areas of leaks. Leaks can be detected by either simple methods (such as the use of soapy water in suspected areas) or advanced methods (for example, the use of ultrasonic acoustic detectors).

Besides increased energy consumption, leaks can add unnecessary compressor capacity, make air tools less efficient and adversely affect production, shorten the life of equipment, lead to additional maintenance requirements, and increase unscheduled downtime.

#### ENERGY PERFORMANCE

By fixing leaks, the energy consumption of the compressed air system can be reduced by up to 20 percent.

#### CAPITAL AND OPERATIONAL COSTS

Typical capital costs for systemic leak management in compressed air systems, combined with system controls, are estimated as follows for different system sizes:

- \$1,250 for <37 kW.
- \$3,000 for 37 kW to 75 kW.
- \$5,000 for 75 kW to 745 kW.<sup>76</sup>

<sup>75</sup> Worell, Galitsky, and Price, *Energy Efficiency Improvement Opportunities for the Cement Industry*.

<sup>76</sup> United Nations Industrial Development Organization, *Motor System Efficiency Supply Curves* (Vienna: 2011).

### 2.6.4.3 COMPRESSOR CONTROLS

The demand patterns in compressed air systems are often dynamic, and therefore few systems operate at full load all the time. Part-load performance of a compressed air system is a critical factor affecting the efficiency of the system and is influenced primarily by compressor type and system controls. When the pressure in the system is higher than what is required, more energy—approximately 7 percent for every extra bar—is consumed.

The objective of any control strategy is to shut off compressors that are not needed or to delay bringing on additional compressors until needed. All units that are on should be running at full load, except for one. Positioning of the control loop also is important; reducing and controlling the system pressure downstream of the primary receiver can result in energy consumption of up to 10 percent or more. Start/stop, load/unload, throttling, multiple (fixed) speed, variable speed, and network controls are options for compressor controls.

### ENERGY PERFORMANCE

Sophisticated controls can provide up to 12 percent energy savings annually. Changing the compressor control from on/zero/off to a variable speed control can save up to 8 percent per year.<sup>77</sup>

### CAPITAL AND OPERATIONAL COSTS

Typical payback for start/stop controls is one to two years.

### COST EFFECTIVENESS PRIORITY

High. Economics also depends on the power price and on the condition of the current system and controls.

---

<sup>77</sup> Worell, Galitsky, and Price, *Energy Efficiency Improvement Opportunities for the Cement Industry*.



Energy efficiency projects are often sound investments that can generate good return and have low risks. Still, important energy efficiency potential remains in all sectors of the economy worldwide, including the industrial sector. The main reason for this is the presence of different market barriers that remain in all markets:

- Unfavorable regulatory framework for energy efficiency measures.
- Lack of awareness about energy efficiency opportunities.
- Lack of knowledge and capacity to identify, develop, and implement projects.
- Lack of capacity to identify gains generated by projects.
- Lack of trust in future energy efficiency project results (that is, in energy savings).
- High internal competition for project support in terms of human and financial resources.
- Production line expansion projects have priority over energy efficiency projects.
- Low energy cost.
- Low carbon emission factor for electricity.
- Lack of adapted and attracted financing.

Specifically related to the last barrier, experts have long recognized that the lack of commercially viable adapted financing is one of the major barriers to implementing energy efficiency projects. Competing for financing with other core business investment projects, energy efficiency projects often rank low on the priority lists of high-level private sector managers or investors.

Energy efficiency financing is distinguished in the following ways:<sup>78</sup>

- In most cases, the assets financed have little or no residual value, making them unusable as collateral against a bank loan.
- The project benefits are “energy and other savings” (that is, money not leaking out of the company, rather than money flowing in, which is a more abstract concept than an increase in revenues, where there is actual cash coming into the company accounts).
- The projects (especially in industry) are more “intricate.” They are not more technically complex than a greenfield investment or a production expansion, but they are more complicated to understand from a banker’s perspective.
- There is a knowledge gap between the engineering companies developing and implementing energy efficiency projects and the beneficiaries (project hosts) and bankers.
- There is a lack of widely adopted and proven measurement and verification standards and protocols for energy efficiency investments. Different countries adopt different guidelines regarding measurement and verification. Also, different engineering companies develop and use their own proprietary models for energy efficiency evaluation. As a result, bankers do not trust the estimated benefits from energy efficiency projects, as they are technical in nature and are derived from non-transparent and non-standardized models. This also makes it very difficult to compare energy efficiency projects.
- Average energy efficiency project size is in the range of €1 million to €5 million, which is considered rather small by local financing institutions.

<sup>78</sup> International Energy Agency (IEA), *Joint Public-Private Approaches for Energy Efficiency Finance* (Paris: 2012).

These properties create a mismatch between the current lending practices of local financial institutions and the needs of energy efficiency projects, making energy efficiency lending discouragingly difficult. Local banks typically:

- Provide asset-based lending limited to 70 percent to 80 percent of asset value (energy efficiency project value = savings).
- Do not believe or acknowledge that cash flow from energy efficiency projects = increased host credit capacity.
- Are not familiar with unique “intricacies” of energy efficiency projects.
- Do not have internal energy efficiency finance capacity to properly evaluate the risks/benefits of energy efficiency projects.
- Lack experience to properly evaluate the risks/benefits of energy efficiency projects.
- Are unwilling to invest in building energy efficiency finance capacity due to the relatively small monetary size of energy efficiency projects.

To address these barriers, various business models were developed and used in different countries that have proved successful.

This section presents different business models that could be considered to facilitate the implementation of energy efficiency projects in the cement industry in Brazil.

## 4.1 DIRECT IMPLEMENTATION

The most conventional way to implement energy efficiency projects is through direct implementation by project beneficiaries. Even though this model does not address many of the identified barriers, it has the advantage of simplicity and good understanding by decision makers.

The use of internal or external expertise, project management, and commissioning are the two main approaches used for this model. To address the financing needs, different approaches have been developed.

### 4.1.1 DIRECT LOANS (SENIOR DEBT)

Direct lending from local financial institutions constitutes the simplest and direct way to finance energy efficiency projects at any facility level. In some cases, the loan can finance a large portion of the requested investment, or, in other cases, the loan can be leveraged with other mechanisms (equity, leasing, etc.). This is known as “senior debt” in the financing world.

The main financial barriers to direct lending are the high interest cost in some countries (such as Brazil), the non-adapted timeframe for repayment, the limitation that it creates on the financing space in relation to competition with other non-energy-efficiency-related projects, as well as the technical risk still being borne by the energy end-user.

When the local financing market is reluctant to provide adapted lending to energy efficiency projects, other organizations—such as national development banks or international financing institutions—for eligible countries can offer such mechanisms through dedicated credit lines. Such credit lines are a dedicated source of credit that is on-lent to financial intermediaries (generally commercial banks) that can use this liquidity to offer loans for developers of energy efficiency investment projects. When a credit line is set, the financial intermediaries are responsible for repayment of the loan and assume all financial risks. In some cases, it has been agreed that the financial intermediaries will lend a percentage of the investment from other source(s) of liquidity to which they have access. The main financial barriers addressed by credit lines are the lack of liquidity or adapted conditions for energy efficiency projects in the market, the competitiveness between all the business opportunities within the financial institutions, and the disinterest of local financial institutions in the energy efficiency business as compared to other traditional opportunities.

**Figure 21:** Structure of Various Financing Methods

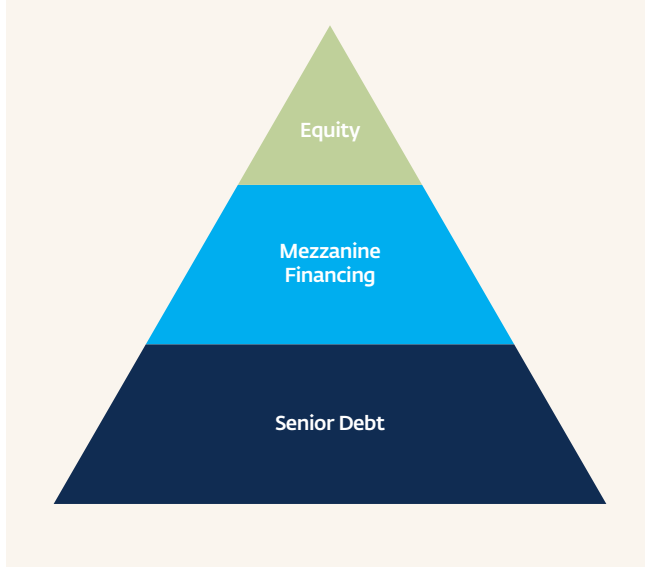

#### 4.1.2 SUBORDINATED DEBT FINANCING (MEZZANINE FINANCING)

Subordinated debt financing, also called mezzanine financing, is capital that sits midway between senior debt and equity and has features of both kinds of financing. Subordination refers to the order or priority of repayments: subordinated debt is structured so that it is repaid from energy efficiency project revenues after all operating costs and senior debt service has been paid.

Subordinated debt is substantially riskier than senior debt since it is generally subordinate to senior debt in terms of collateral rights and rights to cash flow. Subordinated debt financing is generally made available directly from insurance companies, subordinated debt funds, or finance companies. Alternatively, it is raised with public offerings of high-yield bonds to institutional investors. These funds are loaned based on the amount and predictability of energy efficiency project cash flow exceeding that required to service senior debt. Because subordinated debt usually has little collateral protection, the lending institution may be granted stock options to own equity of the outstanding stock.

Subordinated debt funds can be undertaken in partnership with senior lenders. Alternatively, a subordinated credit facility can be provided to the local financial institution, which acts as senior lender; the senior lender then on-lends to the project, blending together the subordinated debt with its senior debt provided from its own resources. The borrower sees one single loan, but the senior lender applies loan payments to repay the senior debt component on a priority basis.

#### 4.1.3 EQUITY FINANCING

Equity financing for energy efficiency projects refers to the acquisition of funds by issuing shares of common or preferred stock of a corporation in anticipation of income from dividends and capital gain as the value of stock rises. Equity is the residual claim or interest of the most junior class of investors in an asset, after all liabilities are paid: ownership equity is the last (residual) claim against assets, paid only after all other creditors are paid. Ownership equity is also known as risk capital or liable capital.

Equity financing can come from professional venture capitalists. Venture capital is a specific sub-segment of private equity investment, which entails investing in startup companies with strong growth potential; private equity entails investment in the expansion and growth of any company that is not listed on a public stock exchange. Venture capital investors obtain equity shares in the companies that provide energy efficiency goods or services and generally play a significant role in the management and technical aspects of the company. Without clear exit paths, typically through resale or initial public offerings, venture capital investors cannot easily commit to the deal, even when they are convinced of the investment potential.

#### 4.1.4 LEASING

Leasing consists in getting new energy efficiency equipment under a rental contract within a determined period. It makes it possible to finance up to 100 percent of the energy efficiency project cost. Leases are guaranteed by the new equipment and usually do not require any other guarantee. Typically, leasing finances large pieces of equipment that can easily be removed from the site and resold (for example, boilers, chillers, compressors, etc.). There are two types of lease: operating lease and capital lease.

##### OPERATING LEASE

An operating lease is a mechanism that involves making regular payments as a standard operating expense with no ownership of the asset by the end-user (lessee) during the lease term. At the end of the lease term, the lessee may purchase the asset at the then-fair market value, return the equipment, or renew the lease for a new lease term. This helps facility owners preserve their corporate line of credit as well as any cash they may have set aside for other business needs, since the transaction is not recorded on the balance sheet of the lessee.

##### CAPITAL LEASE

For a facility owner who prefers to enjoy the benefits of ownership of the assets without actually owning the energy efficiency project assets, a capital lease may be the best financing vehicle. It is still a lease where the facility owner is a lessee, but the lessee has access to any tax and depreciation benefits that the equipment may have. In terms of the facility

owner's balance sheet, the equipment would need to be recorded as a capital asset and the lease payments would be recorded as a liability. At the close of the lease contract term, the energy-efficient equipment transfers ownership to the facility owner for a nominal purchase price.

#### 4.1.5 PARTIAL LOAN GUARANTEES

A partial loan (or credit) guarantee refers to a program administrator who offers credit guarantees to back up loans or leasing issued by financial institutions to project developers. These guarantees are used as collateral for the financial institutions and thus allow them to offer better loan conditions to the project developers. In addition, this removes from the borrowers the burden of using personal assets as guarantees. The program administrator can do this on the base of a fund kept in a reserve account, which can be withdrawn to cover for defaulted payments from the clients of the banks. The loan guarantees may not cover the loans entirely, so that the local financial institutions must accept part of the risks. Partial loan guarantees generally cover up to 90 percent of the investment. The level of coverage is established based on the risk perception of the commercial banks.

The financial barriers mainly addressed by partial loan guarantee activities are the high cost of financing due to high real or perceived risk and the perception of high risk of financial institutions in the energy efficiency business.

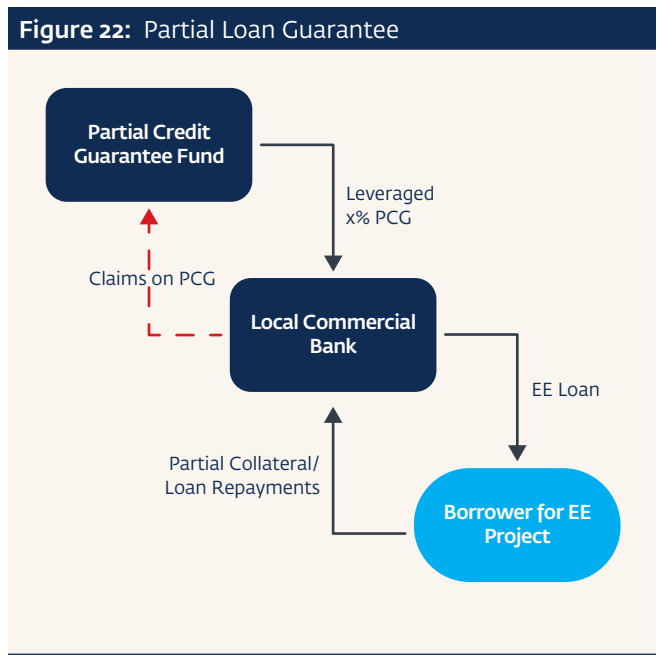

## 4.2 ENERGY PERFORMANCE CONTRACTING MODEL

### 4.2.1 DEFINITIONS AND BASIC CONCEPTS

Energy services companies (ESCOs) develop, implement, and provide or arrange financing for upfront energy efficiency investments for their clients. Repayments from savings allow clients to compensate the ESCO's ongoing savings monitoring, measurement and verification costs, and assumption of risk through energy performance contracting or third-party financing. The fundamental concept of the energy performance contracting business model is that the client does not have to come up with any upfront capital investment and is only responsible for repaying the investment made or arranged by the ESCO.

Three dominant energy performance contracting models have been developed to help address the different market needs in specific sectors: shared savings, guaranteed savings, and "chauffage."

### 4.2.2 SHARED SAVINGS ENERGY PERFORMANCE CONTRACT

In a shared savings energy performance contract, the ESCO finances the total upfront capital cost of the project and is totally responsible for repaying the lender. The client pays the ESCO a percentage (or it can be a fixed amount) of its achieved savings from the project, large enough for the

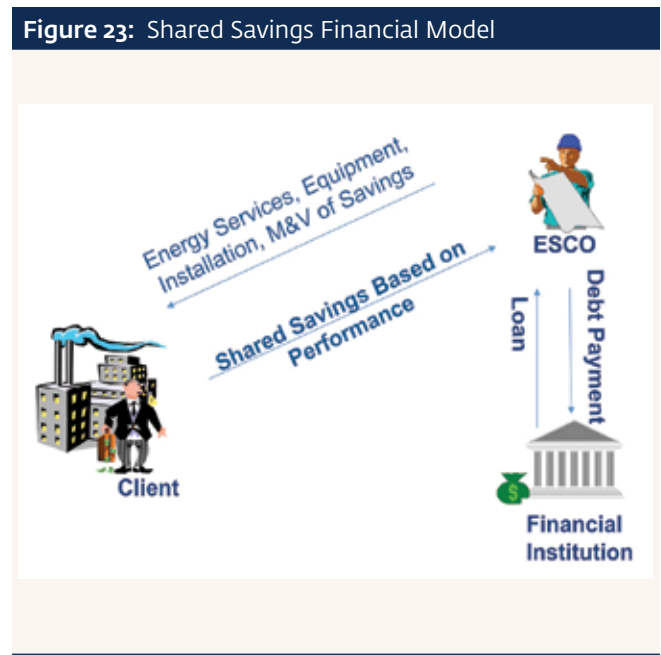

ESCO to repay the project investment to its lenders, cover measurement and verification costs, and pay any other associated costs. The energy end-user assumes no direct contractual obligation to repay the lender; only the ESCO has this obligation.

### 4.2.3 GUARANTEED SAVINGS ENERGY PERFORMANCE CONTRACT

In a guaranteed savings energy performance contract, the client essentially applies for a loan, finances the project, and makes periodic debt service payments to a financial institution. The ESCO bears no direct contractual obligation to repay the lender; only the energy end-user assumes this obligation. The ESCO's guarantee is not a guarantee of payment to the lender, but rather a guarantee of savings performance to the energy end-user that is usually equal to its repayments to the lender.

### 4.2.4 CHAUFFAGE

“Chauffage” or integrated solutions generally refer to a greater value-added approach. The concept offers conditioned space at a specified price per energy unit to be consumed or per some measurable criteria (square footage, production unit, etc.) through a supply-and-demand contract offered by the ESCO. The ESCO manages all supply-and-demand efficiencies. This concept derives from a previous contractual French approach of energy services delivered by a private company to a public authority or to another private body (for example,

Figure 25: “Chauffage” Financial Model

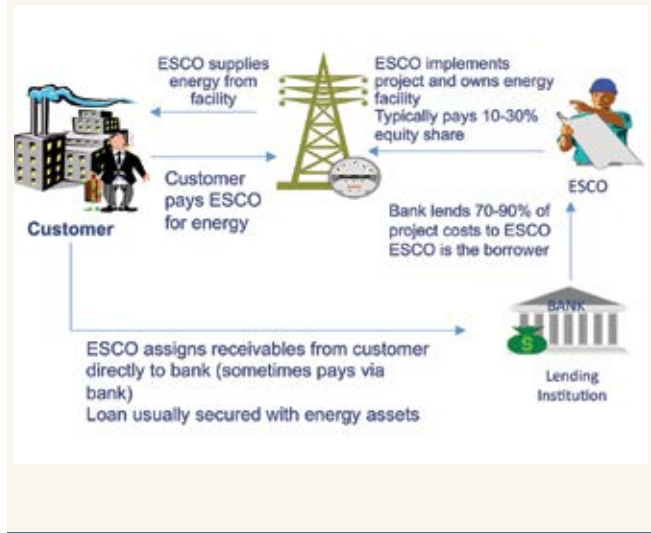

owner of aggregate properties) called “contrat d’exploitation de chauffage” leading to the wording “chauffage” to qualify this form of energy performance contract. In the former French approach, the contract contained up to three elements corresponding to the following services:

- Energy supply cost.
- Maintenance cost.
- Total guarantee cost (replacement cost of the equipment at the end of its life).

Figure 24: Guaranteed Savings Financial Model

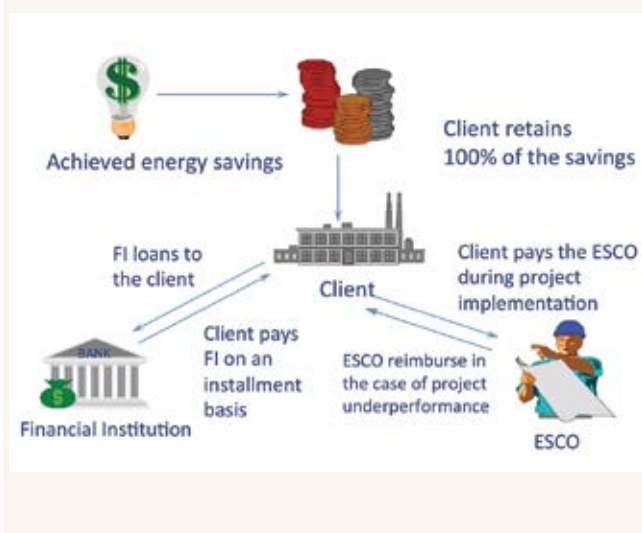

#### 4.2.5 COMPARATIVE ANALYSIS OF THE DIFFERENT MODELS

Table 7 shows a comparison of the various energy performance contracting models along with three important questions.<sup>79</sup>

**Table 7: Energy Performance Contracting Models**

Contract Type	Whose Balance Sheet?	Who Takes Performance Risk?	Project-Specific Financing?
Shared Savings*	ESCO	ESCO	Yes
Guaranteed Savings	Customer	ESCO	Yes
“Chauffage”	ESCO	ESCO	No

\* Note that ESCOs generally sell their right to receive payments from a project to other “third” parties as a means of recovering project investment and working capital to use in future projects.

#### 4.3 PUBLIC-PRIVATE PARTNERSHIP<sup>80</sup>

Public-private partnership for the implementation of energy efficiency projects is a business model that combines the efforts and support of both the public sector and the private sector for design, financing, construction, operation, and management of energy efficiency equipment or projects in public sector facilities. It enables the private sector to finance and engage in public sector investments. Generally, the public sector is responsible for monitoring and evaluation of quality, while the private sector is more closely related to the implementation of the project and the actual service delivery. In addition to public contracts and concessions, this legal form is best suited for heavy operations in which the payment of public service cannot be assured by users. The structure has the advantage of promoting rapid implementation of projects without burdening public finances.

<sup>79</sup> Econoler, *IFC Energy Service Company Market Analysis*, June 23, 2011.

<sup>80</sup> IEA, *Joint Public-Private Approaches for Energy Efficiency Finance*. The text, drafted originally for the IEA by Econoler, has been edited to fit the needs of the present section.

The main features of public-private partnerships include:

- Long-term agreement for delivery of service by a private sector firm in a public sector facility.
- Transfer of risks to the private sector.
- Mobilization of private sector financing.
- Payment to the private sector for the services delivered.
- The goal of delivering a service, which is directly or indirectly related to optimizing energy efficiency at the end-user level.

Public-private partnerships are not a process of privatization of public assets. Under public-private partnerships, accountability for public service delivery is retained by the public sector, whereas under privatization, accountability moves across to the private sector (the public sector might retain some regulatory price control). Under public-private partnerships, there is no transfer of ownership and the public sector remains accountable.

The term “public-private partnership” is not defined in the legislation of many countries. The vast majority of public-private partnerships are in infrastructure projects. However, in recent years, these structures have been used increasingly in energy efficiency implementation and energy efficiency finance. Practice shows that the existence of specific legislation is not crucial for the structuring and implementation of public-private partnerships, particularly those in energy efficiency finance. The partners usually work around the gaps in the local legislation and structure the form and nature of their partnership in public-private partnership contracts.

Supporting legislation, however, can be a catalyst for the development of public-private partnerships. Regulations that make a public-private partnership possible and facilitate its functioning (such as the legal right to establish a project company) or regulations that govern the provision of public financing, where relevant (for example, to provide subsidies or to make long-term commitments of public expenditure for the life of the public-private partnership contract), make the implementation of public-private partnerships much easier. The degree to which public-private partnership structures are being used today for energy efficiency financing depends to

a large extent on the level of sophistication of the different governments and on the development of the judicial systems.

#### 4.4 SPECIAL PURPOSE VEHICLE

The use of a special purpose vehicle consists in the setup of a special-purpose company owned by whomever injects equity in it. The “other project owner” could be, for instance, an equipment vendor with whom the ESCO will partner. It also could be a program administrator or an

international financial institution. Limited partnerships are created for large investments (for example, \$5 million and above) because of the amount of legal and accounting services required, which cause the transaction cost to be very high. It is appropriate for projects in industrial facilities or for the retrofitting of many facilities owned by a single entity (for example, a municipality or a state government). Nevertheless, it is a very innovative scheme that makes it possible to fine tune the risk assignment.

**Figure 26:** Special Purpose Vehicle Financial Model

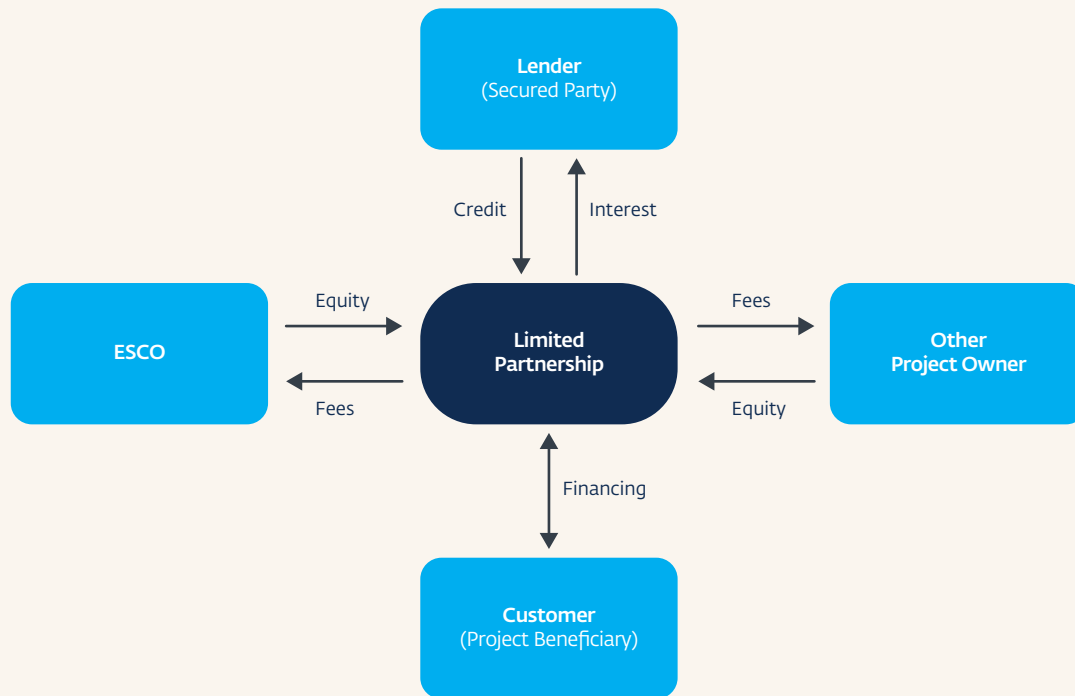

Source: Adapted from C. Bullock and G. Caraghiaur, *A Guide to Energy Services Companies* (The Fairmont Press / Prentice Hall, 2000).



# INTERNATIONAL BEST PRACTICE BUSINESS MODELS FOR IMPLEMENTING ENERGY EFFICIENCY PROJECTS IN INDUSTRY

# 5

Several examples of successful business models exist throughout the world. This section covers those models that are considered most relevant for the Brazilian cement sector. More examples can be found in publications such as the Institute for Industrial Productivity's *Delivery Mechanism for Financing of Industrial Energy Efficiency*;<sup>81</sup> the Inter-American Development Bank booklet *Programas de Financiamiento de Eficiencia Energética*,<sup>82</sup> written by Econoler; and the International Energy Agency publication *Joint Public-Private Approaches for Energy Efficiency Finance*,<sup>83</sup> co-written by Econoler.

## 5.1 LENDING PROGRAMS

### 5.1.1 PROMOTING AN ENERGY EFFICIENCY MARKET IN CHILE

#### INTRODUCTION

The program, implemented through the Chilean Energy Efficiency Agency (AChEE), aims to facilitate the implementation of energy efficiency projects in several sectors. The estimated cost of the program is \$42.35 million; of this, the Global Environment Facility (GEF) will finance (grant) \$2.64 million, which will be administered by the Inter-American Development Bank. In addition, \$39.72 million in co-financing will be provided by project partners (\$3.69 million from AChEE; \$31.89 million from CORFO; \$0.98 million from the Inter-American Development Bank, and \$3.14 million from the beneficiary small and medium enterprises).

81 Institute for Industrial Productivity, *Delivery Mechanisms for Financing of Industrial Energy Efficiency: A Collection of Best Practices* (Washington, DC: 2012).

82 Inter-American Development Bank, *Programas de Financiamiento de Eficiencia Energética: conceptos básicos* (Washington, DC: 2012).

83 IEA, *Joint Public-Private Approaches for Energy Efficiency Finance*.

- The general objective is to promote and strengthen energy efficiency in the industrial and commercial sectors in Chile.
- The specific objectives are to:
  - Obtain a critical mass of trained government staff, energy efficiency auditors and consultants, as well as representatives from the industrial and commercial sectors, with on-site practical experience of available technologies for energy efficiency, including their implementation and measurement and verification of energy savings.
  - Provide the necessary tools to make financing options available to end-users and ESCOs.
  - Provide practical experience in design and implementation of energy efficiency measures and verify energy efficiency projects in specific identified areas.

#### BARRIERS TARGETED

The program addresses the following barriers to energy efficiency financing:

- **Lack of knowledge of energy efficiency in the industry and of capacity to develop energy efficiency projects.** This barrier is targeted through the solid technical assistance package integrated in the program and through the investment in the program of a number of market stakeholders. AChEE is actually a private energy efficiency agency, and, as such, it makes sure that the program is designed and implemented on a commercial basis, not distorting or conditioning the market.
- **Limited access of small and medium enterprises to energy efficiency financing.** The program will actually focus on small and medium enterprises and ESCOs, which in Chile also are small companies with small project development and implementation capacities. A large portion of

the technical assistance package will target small and medium enterprises and information awareness issues.

- **Lack of technical capacity at the local financial institution level to evaluate energy efficiency projects.** Through evaluation of existing credit lines and investment facilities, the program aims to suggest energy efficiency financing mechanisms that address the current barriers and issues.

### DESIGN OF THE MECHANISM

To address the above barriers, the program design includes a package with the following components:

- **Institutional strengthening and capacity building in energy efficiency.** The technical support package aims to consolidate AChEE as a “one-stop shop” for energy efficiency by increasing the know-how in energy efficiency, establishing an energy efficiency strategy for the country and its implementation plan, and developing a communication strategy to create awareness among the rest of the market stakeholders. The package also will finance workshops and seminars on energy efficiency program design and evaluation, benchmarking, risk assessment of energy efficiency projects, as well as measurement and verification protocols to be taught to AChEE staff members, ESCOs, and market stakeholders.
- **Implementation of energy efficiency pilot projects** in selected and prioritized areas.
- **Development of energy efficiency financial mechanisms** through evaluation of several existing energy efficiency credit lines and a partial guarantee fund. This component also will provide recommendations for optimization of the existing financial instruments and development, testing, and dissemination of a standardized process for assessing loan applications for energy efficiency investments.

### MARKET IMPACT

This is still an ongoing program, and, as yet, there are no reports on its implementation progress and market impact. However, program results will be monitored by two groups of indicators:

- **Direct measurements** (for example, reports on energy savings resulting from pilot projects and other energy efficiency investments facilitated by the GEF project calculations greenhouse gas emission reductions through the method in the GEF guideline).
- **Indirect measurements** (for example, the amount of resources invested in energy efficiency projects in small and medium enterprises implementing technologies promoted by the project).

It will be good to monitor on a regular basis the implementation of this program, as it has the embedded versatility and potential to have a positive impact in Chile and also to increase the awareness of energy efficiency in the market. Because this is reimbursable program, it is expected to run for some time and to compound the market transformation effect.

### 5.1.2 CHINA UTILITY-BASED ENERGY EFFICIENCY PROGRAM (CHUEE)

#### INTRODUCTION

The CHUEE program is implemented by IFC in China. Although the name suggests that the program is linked to a utility, this is not the case. Initially, the program was designed to promote the switch from coal to natural gas and was to be implemented through a gas utility in China. However, this concept was abandoned due to misalignment of interests, and the program evolved into a partial guarantee mechanism, disbursed through local banks in China.

After a successful Phase I in 2006, the program was repeated as Phase II in 2009. Currently, a Phase III is ongoing. The lessons learned from the first two phases have been described in detail in the impact assessment report of the first two phases.<sup>84</sup>

#### BARRIERS TARGETED

The program was based on market research, which assessed the market constraints to energy efficiency in China. Several major barriers were identified as key targets for the program:

- **Lack of information at the level of end-users**, which limits their ability to understand the energy efficiency savings

---

<sup>84</sup> World Bank, *Assessing the Impact of IFC's China Utility-Based Energy Efficiency Finance Program* (Washington, DC: 2010).

potential at their facilities, to develop energy efficiency projects, and to assess the risks of such projects.

- **Lack of awareness and experience among Chinese commercial banks** about financing energy efficiency projects.
- **High risk aversion among local banks in China.**
- **Use of asset-based lending as the only approach to lending by local banks**, which discredited energy efficiency stakeholders such as equipment suppliers and ESCOs that have a weaker asset base.

### DESIGN OF THE MECHANISM

The design reflected the objectives of the program to target the above barriers. The CHUEE design had three main components:

- **An energy efficiency partial credit guarantee mechanism.** This was a mechanism intended to overcome the risk-averse behavior of Chinese banks and to give them an incentive to experiment and lend to energy efficiency projects. The partial credit guarantee, provided by the program was a “first-loss,” where IFC would cover:
  - 75 percent of the first 10 percent losses of the Chinese bank
  - 40 percent of the remaining 90 percent losses of the Chinese bank.
- **A technical assistance package for capacity building of market players.** This boosted the capacity of the participating banks and changed the role of the banks from financing-only to providing project development guidance plus financing.
- **Development of an energy efficiency awareness component.**

**Figure 27:** Institutional Arrangements of CHUEE Program

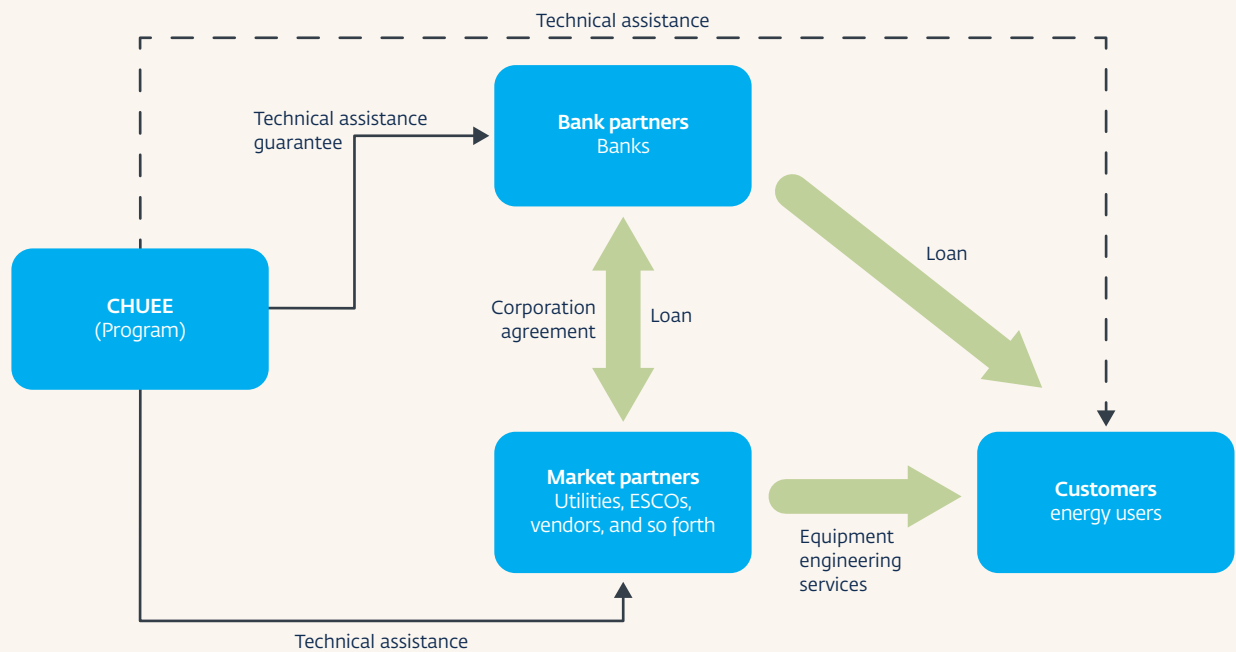

Source: IEG

Note: CHUEE = China Utility-Based Energy Efficiency; ESCOP = energy service company.

The total funds allocated to the program were \$215.5 million (including the technical support components).

### MARKET IMPACT

In the first two phases of the program, the local banks provided a total of \$512 million in loans for energy efficiency projects. The environmental impact was estimated at 14 million tons of carbon dioxide per year, which exceeds the target set by IFC at the design stage.

Apart from the market transformation impact, the effect was much more pronounced at the level of the two participating banks (Bank of Beijing and Industrial Bank). CHUEE practically started the energy efficiency lending business for the two banks, and it continued in a sustainable manner after the end of Phase II of the program. The exposure to energy efficiency transactions of the two banks was significantly influenced by CHUEE, and now they have a much higher proportion of energy efficiency transactions in their loan portfolios, compared to competitor banks.

A number of lessons were learned from this program, which can be transferred to the Brazilian market context:

- For programs that aim for market transformation, careful selection of the local partner banks is required as a prerequisite for success.
- Flexibility in the program design is a key to help respond to unexpected market changes.
- Supporting government policies are a strong market driver that can influence the implementation of the program.
- Indiscriminate use of subsidies impedes the commercialization of energy efficiency finance.
- Caution is needed when applying a utility-based model in emerging markets.
- A program exit plan is critical to success.

A number of recommendations were made for Phase III of the program (CHUEE III), such as:

- The additionality from the experience of the involved international financial institution should be exploited as much as possible.
- Market focus should be on sectors that have high potential for energy efficiency savings but are currently overlooked by local banks.
- Subsidies should be used in areas with market failures. To the extent possible, energy efficiency financing should be done on a commercial basis.

### 5.1.3 BANGKOK MITSUBISHI UFJ LEASE LTD (BMUL) RISK-SHARING PROJECT

#### INTRODUCTION

The project entails the development of a risk-sharing facility to support the energy efficiency, renewable energy, and ESCO sectors. It will contribute to increasing efficiency in industry, reduction of operating costs, and pollution reduction. Thailand is heavily dependent on energy as an input and has one of the highest electricity rates in the Southeast Asia region.

The total size of the facility is estimated to be \$70 million, and IFC investment totals \$36.81 million. BMUL would be responsible for generating a portfolio of energy efficiency leases. IFC will share the risk of that lease portfolio, which will include support from the Clean Technology Fund.

#### BARRIERS ADDRESSED

Leasing comes as an alternative to bank lending. The different set of regulations governing the leasing business makes leasing companies more flexible and particularly suitable to financing energy efficiency equipment.

The main barrier addressed by the program in Bangkok was the high perceived risk of energy efficiency investments by local financial institutions, and respectively the high requirements for collateral and business cash flows from borrowers.

#### DESIGN OF THE MECHANISM

The program is designed to skim the market for viable energy efficiency projects, where different pieces of efficient

equipment are being installed, replacing old and obsolete equipment. By design, the equipment itself is enough as collateral on the transaction. The leasing mechanism, although not targeting the entire energy efficiency market potential, focuses on a good portion of the market and has a unique market transformation effect.

The program will contribute to the development and diversification of the financial sector by assisting in the development of new markets and product lines with significant growth potential. The risk-sharing facility by IFC will provide comfort and reduce risks taken by financial institutions, especially those entering into such new markets in Thailand for the first time.

#### *IMPACT*

The project is still ongoing, but it is expected to contribute largely to the increase in efficiency in the industry sector as well as to the reduction in operating costs. In addition, the project will contribute to pollution reduction by increasing the use of more-efficient technologies with fewer harmful side effects.

## **5.2 EQUITY FINANCING (PRIVATE EQUITY, RISK/ VENTURE CAPITAL, ETC.)**

### **5.2.1 CLEAN RESOURCES ASIA GROWTH FUND**

#### *INTRODUCTION*

Although equity financing takes only a small niche in the energy efficiency financing market, this program is an interesting approach to energy efficiency financing in the general framework of clean energy support. CLSA Capital Partners Limited, a financial institution with a strong presence in Asia, is raising the Clean Resources Asia Growth Fund, a \$200 million clean technology fund. The Fund will target opportunities across the value chain within the clean technology sector, including several areas that are currently underserved by capital sources:

- Pollution and waste management technologies.
- Water and wastewater solutions.
- Sustainable agriculture technologies.
- Energy efficiency technologies.
- Supply chain investments for alternative energy.

#### *BARRIERS*

The main barrier to be addressed is the lack of low-cost energy efficiency, renewable energy, and sustainable energy technologies in the region.

#### *DESIGN OF THE MECHANISM*

The Fund will invest in a diversified portfolio in the Asia-Pacific region. The Fund is expected to consist of a portfolio of 10 to 12 companies with investments generally ranging from \$10 million to \$30 million.

#### *IMPACT*

By providing equity financing to companies in the business of technology transfer in the clean technology space, the lack of knowledge should be reduced because of:

- Adoption of more sustainable practices.
- Dissemination of low-cost technologies to developing markets.
- Global improvement in clean energy technology in Asia.

## **5.3 PARTIAL GUARANTEE MECHANISM**

### **5.3.1 THE ENERGY EFFICIENCY GUARANTEE MECHANISM**

The Energy Efficiency Guarantee Mechanism (EEGM)<sup>85</sup> is a \$25 million mechanism exclusively for buildings, including industrial buildings. However, projects related to the improvement of the process are excluded. The mechanism is the result of a partnership between the Inter-American Development Bank, the United Nations Development Programme, and the GEF, which offers partial credit guarantees of up to 80 percent of the value of the energy efficiency contract, or up to 100 percent of the financed amount, for the maximum term of seven years, in the form of two guarantee products:

- The comprehensive risk guarantee: covers defaults for technical and financial creditworthiness reasons. This product is available to financial institutions, ESCOs, and their clients. The EEGM takes up to 80 percent of

---

85 Energy Efficiency Guarantee Mechanism, <http://eegm.org>.

the payment risk of the borrower participating in the underlying energy efficiency contract (credit risk).

- The technical risk guarantee: covers defaults due to technical reasons. This product is available to financial institutions and ESCOs. The EEGM takes up to 80 percent of the performance risk of the underlying energy efficiency contract.

The EEGM emits guarantees for a period of five years and offers a maximum tenor of seven years. The guarantees are done in Brazilian reais within the following limits:

- Minimum Guarantee: \$100,000 (equivalent in Brazilian reais) (within the maximum percent per project)
- Maximum Guarantee: \$1,600,000 (equivalent in Brazilian reais) (within the maximum percent per project).

### 5.3.2 KRAKOW ENERGY EFFICIENCY PROJECT

A good example is the Krakow Energy Efficiency Project, where a GEF-supported<sup>86</sup> partial credit guarantee mechanism is implemented through the Polish State Bank BGK (Bank Gospodarstwa Krajowego). Apart from monitoring the performance indicators, set in the project design, the following contract management aspects were involved:

- Contract between GEF and BGK (as representative of the Government of Poland)
- Contract between BGK and partner banks.

## 5.4 ESCO BUSINESS MODELS

### 5.4.1 GREEN FOR GROWTH FUND

#### INTRODUCTION

The proposed project envisages an IFC investment in the Green for Growth Fund (GGF), Southeast Europe SA SICAV-SIF (formerly known as the Southeast Europe Energy Efficiency Fund, SA SICAV-SIF) (the Fund), which was launched in December 2009.

<sup>86</sup> Global Environment Facility, "Krakow Energy Efficiency Project," <http://gefonline.org/projectDetailsSQL.cfm?projID=786>.

**Figure 28: Krakow Energy Efficiency Project**

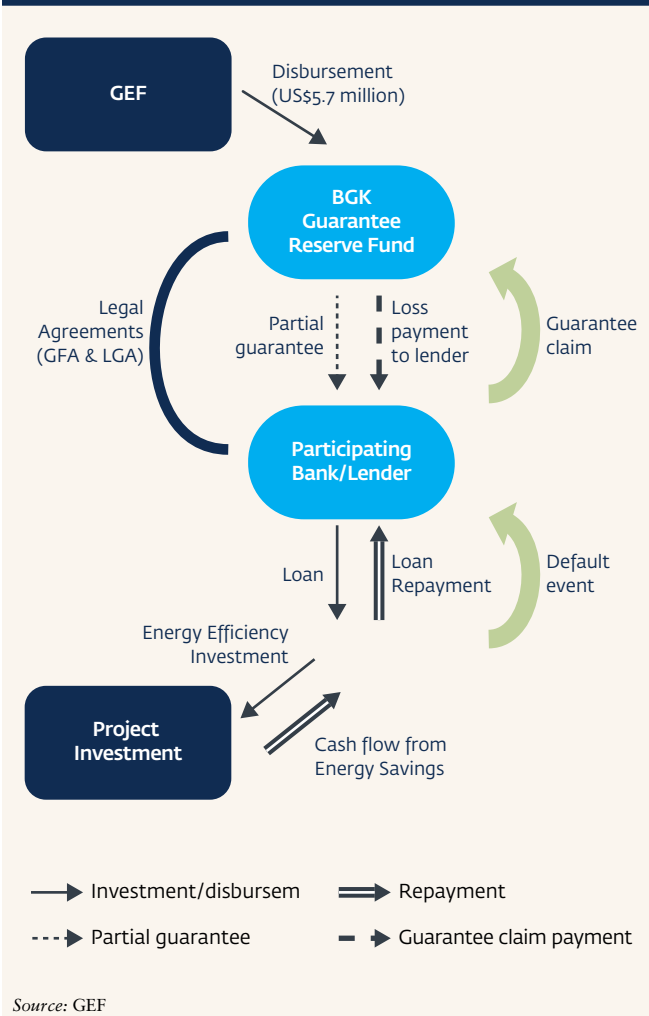

#### BARRIERS

The main barriers to be addressed are:

- Limited access to sustainable energy finance.
- Lack of knowledge in energy conservation, energy efficiency, and renewable energy.
- Low interest of private investors in renewable energy and energy efficiency.

#### DESIGN OF THE MECHANISM

Promoted by KfW Entwicklungsbank and the European Investment Bank, the Fund is a proposed €400 million collective debt investment vehicle that will provide financing for on-lending to sustainable energy projects through financial institutions, ESCOs, and renewable energy/

energy efficiency projects/companies and service and supply companies, collectively partner institutions in the Southeast European Region. More specifically, the GGF:

- Provides financing arrangements to ESCOs for projects that aim to achieve a minimum of 20 percent energy or carbon dioxide savings. Eligible measures are energy efficiency and renewable energy projects, energy performance contracting projects, or energy supplying contracting projects.
- Provides medium- to long-term financing for energy efficiency and renewable energy products/projects to strong and reputable commercial banks, microfinance institution leasing companies, and other non-bank financial institutions committed to the same energy-saving objectives. The financial institutions on-lend these funds to sub-borrowers such as households, household associations, small and medium enterprises, large business, municipalities, public sector entities, and renewable energy projects.

- Provides financing to energy efficiency/renewable energy service or equipment manufacturing companies that require funding for growth capital to expand their business.
- Builds beneficial relationships with companies that have compelling business models and well-defined growth strategies.
- Offers structured and tailored senior debt, mezzanine, project finance, and equity products, pursuing proven high-growth energy technologies and services.

#### IMPACT

The project is expected to have a significant developmental impact in promoting energy efficiency and renewable energy and expanding lending to households, small and medium enterprises including ESCOs, municipalities, and public sector entities in Southeast Europe. Key developmental impacts include:

- Broadening access to sustainable energy finance.
- Demonstrated effects of improved energy efficiency among sub-borrowers.

**Figure 29:** Green for Growth Fund Institutional Structure

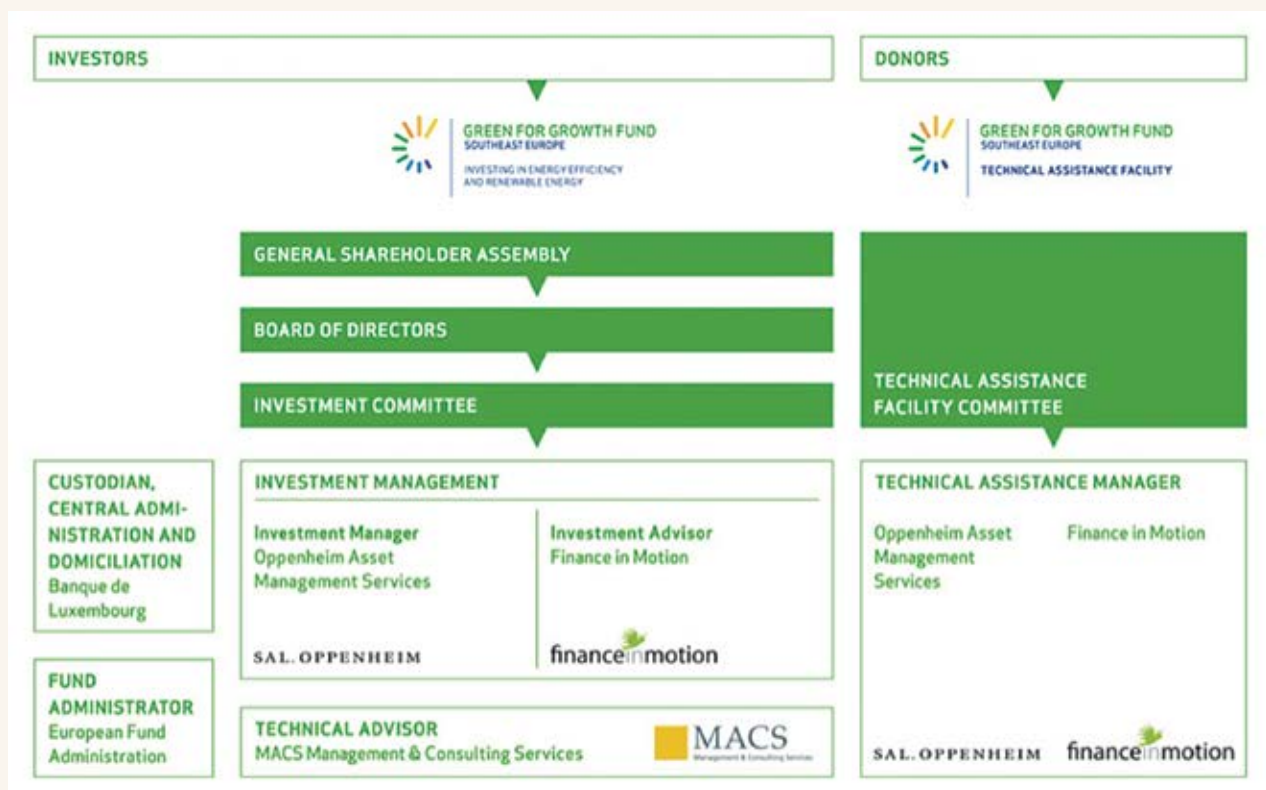

Source: <http://www.ggf.lu>

# 6

## BRAZILIAN MECHANISMS TO SUPPORT THE USE OF DIFFERENT BUSINESS MODELS

A limited number of mechanisms are available in the Brazilian market to support energy efficiency investment in the industrial sector.

### 6.1 TAKING ON DEBT

The Banco Nacional de Desenvolvimento Econômico e Social/BNDES (National Bank for Social and Economic Development) is the biggest and leading agent for the financing of long-term projects and investments in Brazil. The BNDES is a state-owned bank that acts as the instrument of government policies on credit for long-term developments. As such, the bank has access to long-term financing under favorable conditions and can offer longer-term and less-expensive funds than other financial institutions. The BNDES is the main financing agent of energy efficiency projects in the Brazilian market.

The bank has developed a number of financing instruments over the last few years, and several of them are dedicated to the industrial sector.<sup>87</sup> The BNDES provides two financing modalities: direct and indirect financing. To qualify for direct financing, the borrower must submit a “previous consultation” document that has to be approved by the bank. The Finem is the BNDES product used for the direct financing of investment projects, even though some financing programs allow direct financing in specific cases. Only projects of more than 20 million Brazilian reais qualify for direct financing, but there are exceptions for specific cases. Indirect financing, the other modality, requires resorting to accredited financial institutions. In these cases, the analysis of the credit facility is made by the accredited financial institution, which negotiates the financing conditions—such as payment terms and required guarantees—with the client. The accredited financial institution complies with the rules

and the limits defined by the BNDES and undertakes the related credit risks.

The isolated acquisition of machines and equipment requires automatic indirect financing, regardless of the amount, obtained through Cartão BNDES or FINAME. Automatic indirect financing of projects requires the use of the BNDES Automático product.

The main products offered by the BNDES for the industrial sector are as follows:

- **BNDES Finem:** for the financing of business ventures of more than 20 million Brazilian reais. This product has a high number of lines, with specific characteristics, depending on the sector or program. One line is dedicated to energy efficiency, Finem–linha Eficiência Energética.<sup>88</sup>
- **BNDES Finame:** indirect financing for new, Brazilian-made machines and equipment. Among the several lines that can be used for energy efficiency investments, one of the most appropriate is the Bens de Capital–Commercialização–Aquisição de Bens de Capital (BK Aquisição) line for the acquisition of new, Brazilian-made machines and equipment. There is also a leasing facility, Finame Leasing, that could be used for specific Brazilian-made machines and equipment.
- **BNDES Automático:** indirect financing of investment projects of up to a maximum of 20 million Brazilian reais. This product has several lines. In relation to energy efficiency initiatives, the most appropriate one is the Linha Médias–Grandes e Grandes Empresas–Demais Setores line.

<sup>87</sup> BNDES, “Indústria, comércio e serviços,” [http://www.bndes.gov.br/SiteBNDES/bndes/bndes\\_pt/Areas\\_de\\_Atuaacao/Industria/](http://www.bndes.gov.br/SiteBNDES/bndes/bndes_pt/Areas_de_Atuaacao/Industria/).

<sup>88</sup> BNDES, “Temos as melhores opções de financiamento para você,” [http://www.bndes.gov.br/SiteBNDES/bndes/bndes\\_pt/Institucional/Apoio\\_Financeiro/Produtos/FINEM/eficiencia\\_energetica.html](http://www.bndes.gov.br/SiteBNDES/bndes/bndes_pt/Institucional/Apoio_Financeiro/Produtos/FINEM/eficiencia_energetica.html).



- **BNDES Project Finance program:** This program is applicable under very specific conditions outlined on the program webpage.<sup>89</sup>

## 6.2 ENERGY PERFORMANCE CONTRACTING

Brazil has had firms providing specialized energy efficiency project services since the early 1990s, as well as an ESCO association, ABESCO, since 1997. ABESCO, the Brazilian Association of Energy Services Companies,<sup>90</sup> is a nonprofit entity that officially represents the segment of Brazilian energy efficiency, representing ESCOs and encouraging and promoting activities and projects for the growth of the energy market. According to ABESCO, several financing lines exist for financing energy efficiency projects,<sup>91</sup> including the BNDES lines presented above.

The majority of the ESCOs associated with ABESCO are in fact energy consultants, as they do not all necessarily work with energy performance contracts and do not follow the typical ESCO type of company management. Several professionals (the majority), who work in individual companies as consultants, originally came from

academia. Some still work as university professors and serve as consultants as well. Others are small consulting or engineering firms that focus on energy efficiency projects.

Out of the 90-plus ESCOs associated with ABESCO, only about 5 or 6—the largest ones—count as “real” ESCOs, working in the typical business model (in energy performance contracting). Several—including Efficientia (CEMIG, Minas Gerais) and Light ESCO (Light, Rio de Janeiro)—were founded by utilities as a project implementation arm. Other large private ESCOs include APS Engenharia and Vitalux Eficiência Energética. Those ESCOs have implemented projects in the industrial sector, including in the cement sector.

According to a 2014 survey conducted by Econoler, the commercial, services, and industrial sectors are the main potential clients of both big and small companies. The big companies that work 100 percent under energy performance contracting all stated that they focus all of their efforts on the industrial sector.

---

<sup>89</sup> Ibid.

<sup>90</sup> ABESCO, <http://www.abesco.com.br/pt/>.

<sup>91</sup> ABESCO, “Formas de Financiamento de Projeto,” 2015, <http://www.abesco.com.br/pt/forma-de-financiamento/> (February 21).

NOTES



